

MULTIWASH III

MICROPLATE WASHER

OPERATION AND MAINTENANCE MANUAL



DECLARATION OF CONFORMITY

We, TriContinent Scientific, Inc. declare under our sole responsibility that the following products:

Microplate Washer

Model Numbers: 8441-XY, Where X= (0 thru 9), Y=(0 thru 9)

to which this declaration relates is in conformance with the following standards:

EN61010-1:2010

EN61326-1:2013

EN61326-2-6:2013

Following the provisions of the 2014/35/EU and 2014/30/EU Directives.

Authorized representative established in the European Community and person, who is authorized to compile the technical file:

Gardner Denver Thomas GmbH
Livry-Gargan-Str. 10
82256 Fürstenfeldbruck/Germany

TriContinent Scientific, Inc.
12740 Earhart Avenue
Auburn, CA 95602

Jennifer Gracianette, Quality Supervisor

7/13/18
Date of Issue

Jennifer Gracianette
Signature



CONTENTS

1	INSTALLATION	1
1.1	UNPACKING	1
1.2	ENVIRONMENTAL REQUIREMENTS	1
1.3	AC LINE VOLTAGE SELECTION	2
1.3.1	120 LINE VOLTAGE SELECTION	2
1.3.2	220 LINE VOLTAGE SELECTION	3
1.4	MANIFOLD INSTALLATION	4
1.5	MANIFOLD ALIGNMENT	5
1.5.1	THUMBSCREW ADJUSTMENT	5
1.5.2	HORIZONTAL MANIFOLD TO MICROPLATE ADJUSTMENT	6
1.5.3	VERTICAL MANIFOLD TO MICROPLATE ADJUSTMENT	8
1.6	SETTING UP THE RESERVOIRS	10
2	FUNCTIONAL DESCRIPTION	11
2.1	INTRODUCTION	11
2.2	DISPENSING	11
2.3	ASPIRATION	11
2.4	WASH CYCLE OPTIONS	12
2.5	KEYPAD	12
2.6	DISPLAY	13
2.7	AUTORINSE VALVE	13
3	OPERATION	14
3.1	OVERVIEW	14
3.1.1	STRIP WASH MODE	14
3.1.2	PLATE WASH MODE	14
3.1.3	PRIME	14
3.1.4	RINSE	15
3.1.5	ROWS	15
3.1.6	AUTOMATIC STANDBY-ROW REFILL	15
3.1.7	WASTE RESERVOIR FULL SENSOR	15
3.2	OPERATING INSTRUCTIONS SUMMARY	16
3.3	PROGRAMMING A WASH CYCLE	17
3.3.1	PROGRAM NUMBER	17
3.3.2	MANIFOLD/SELECT	17
3.3.3	DISPENSE VOLUME	17
3.3.4	DISPENSE SPEED	18
3.3.5	SOAK SECONDS	18
3.3.6	WASH CYCLES	18
3.3.7	STRIP/PLATE MODE WASH	18
3.3.8	U/V PLATE SELECTION	19
3.3.9	ROWS	19
3.3.10	START/STOP	19
3.3.11	USER DEFINED PROGRAM LOG SHEET	20

CONTENTS (CONTINUED)

4	MAINTENANCE	22
4.1	GENERAL	22
4.2	MAINTENANCE SCHEDULE AND SERVICE RECORD	22
4.3	INLET LINE FILTERS-WASH AND RINSE RESERVOIRS	22
4.4	ASPIRATE EXHAUST FILTER	22
4.5	DISPENSE PUMP AND SYRINGE ASSEMBLY ON BACK PANEL	25
4.6	CLEANING MANIFOLD NEEDLES	26
4.7	REPLACING STANDARD MANIFOLD DISPENSE NEEDLES	27
4.8	INSTALLING MANIFOLD TUBING (CONTINUED)	28
4.9	FUSE MODULE REMOVAL AND FUSE INSTALLATION INSTRUCTIONS	29
4.10	DECONTAMINATION PROCEDURE	30
5	TROUBLESHOOTING	31
5.1	RE-INITIALIZING THE STORED PROGRAMS	31
5.2	TROUBLESHOOTING TABLE	31
5.3	ERROR CODES	34
5.4	USER TROUBLE SHOOTING NOTES	35
6	SPECIFICATIONS	36
6.1	PERFORMANCE	36
6.2	MECHANICAL/ELECTRICAL	36
APPENDIX 1	ACCESSORIES AND REPLACEMENTS	37
APPENDIX 2	ORDERING INFORMATION/CUSTOMER SERVICE	37
	WARRANTY	37
	WORKMANSHIP AND MATERIALS	37
	SERVICING	37
	EXCLUSIONS	37
APPENDIX 3	QUICK START GUIDE	38

(THIS PAGE INTENTIONALLY LEFT BLANK)

1 INSTALLATION

1.1 UNPACKING

REFER TO THE INSTRUCTIONS AND PICTURES ON THE BOX.

1. Place the shipping carton on the floor for easy access and removal of equipment.
2. Remove the reservoir kit using the pull handle.
3. Remove the foam cushions from the sides.

IMPORTANT: DO NOT LIFT THE WASHER BY HOLDING THE SYRINGE ON THE BACK OF THE INSTRUMENT.

4. Place hands UNDER the front and rear of the instrument and pull up to remove instrument from the carton.
5. Remove the accessories and AC line cords from the box.
6. Refer to the shipping checklist below to verify that all items on the list have been received.
7. Inspect all components for shipping damage. In case of damage, contact the shipper who delivered your equipment.
8. Save all packaging material in case it becomes necessary to return the instrument.

Shipping Checklist

MultiWash III instrument

Reservoir kit (Wash, Rinse and Waste)

AC Power Supply Cables (USA domestic, 120V; European, 220V)

Bag containing spare fuses, instructions and soaking microstrip wells

This manual: MultiWash III Operation and Maintenance,
Quick Start Guide

1.2 ENVIRONMENTAL REQUIREMENTS

Locate the MultiWash III so that it is shielded from excess exposure to dust, vibration, strong magnetic fields, direct sunlight, drafts, excessive moisture, or large temperature fluctuations. A surge protector or line conditioner should be used with the instrument if the voltage source is not stable. Sudden voltage spikes can cause damage to the electronics inside the instrument.

Operating temperature: 10° to 40°C

Storage temperature: 1° to 40°C

Operating altitude: Up to 2000 Meters

Maximum relative humidity: 80%, non-condensing up to 31°C decreasing linearly to 50% relative humidity at 40°C

Pollution: Degree II

Equipment installation: Minimum of 20 cm required between back panel assembly and walls or objects to service fuses and AC line cords. Use exclusively the original power cords supplied with the MultiWash III. Grounding circuit continuity is vital for the safe operation of equipment. Never operate equipment with the grounding conductor disconnected. Use of the MultiWash III in a manner not specified may result in the protection provided by the instrument to be impaired.

1.3 AC LINE VOLTAGE SELECTION

This instrument was supplied with a Fuse Module and two different types of spare fuses. The Fuse Module is ready to be installed into the Power Entry Module located on the back of the instrument as shown in the following examples. The Fuse Module must be installed into the Power Entry Module so that the proper voltage for your area is shown in the correct manner, as illustrated. If you are not sure of the setting that is right for your area, contact your local power company.

1.3.1 120 LINE VOLTAGE SELECTION

The small arrow below the selected "110-120V" voltages shown on the Fuse Module must be aligned with the **WHITE** arrow on the Power Entry Module for proper OPERATION.

 **WARNING! Disconnect power cord before continuing onto the next steps!**

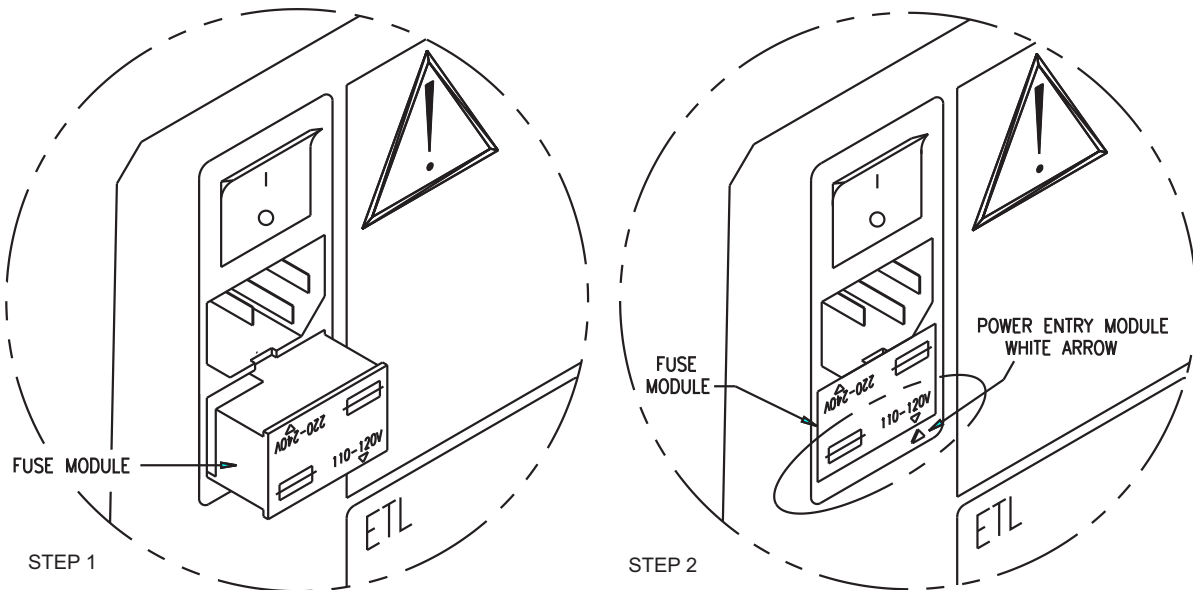
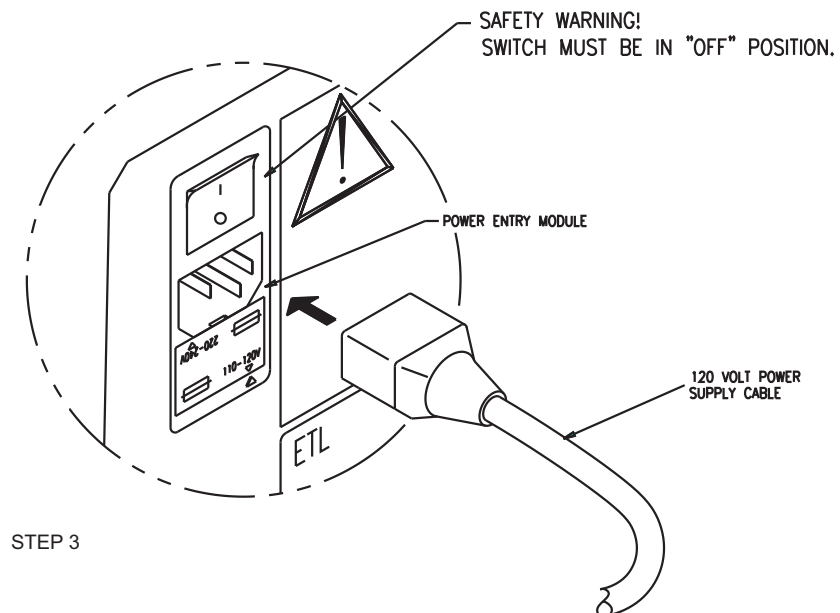

ILLUSTRATION OF THE PROPER ORIENTATION OF THE FUSE MODULE FOR OPERATION IN THE VOLTAGE RANGE OF 99 TO 132 VOLTS



1.3.2 220 LINE VOLTAGE SELECTION

The small arrow below the selected "220-240V" voltages shown on the Fuse Module must be aligned with the **WHITE** arrow on the Power Entry Module for proper operation.

 **WARNING! Disconnect power cord before continuing onto the next steps!**

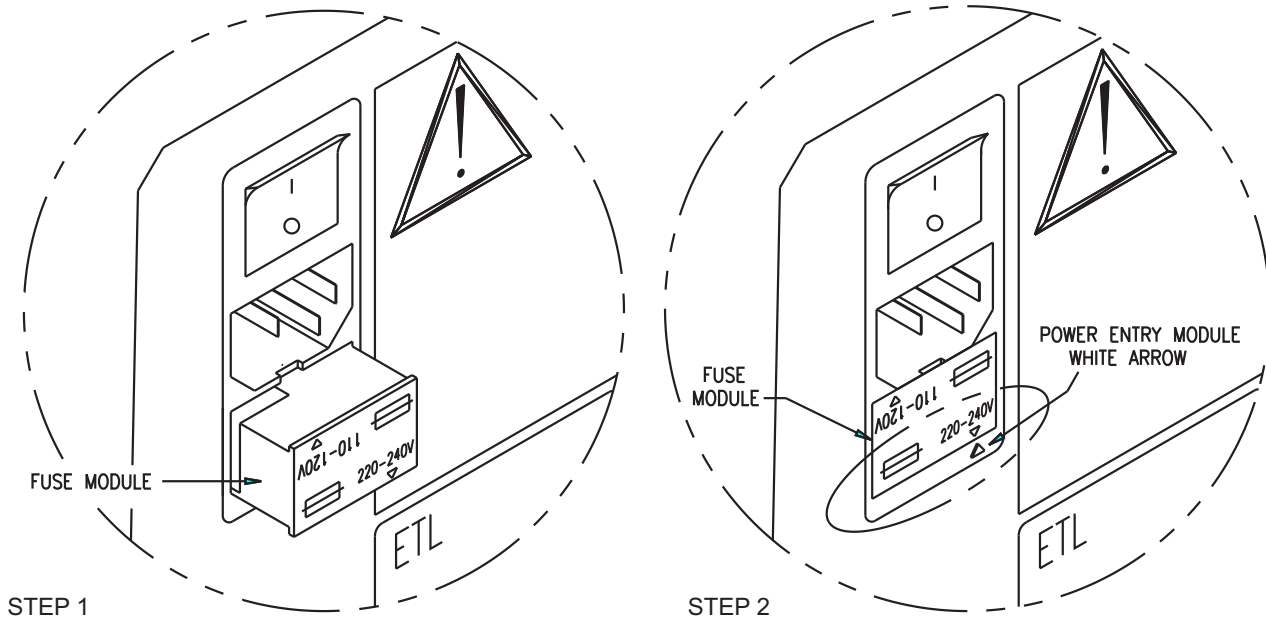
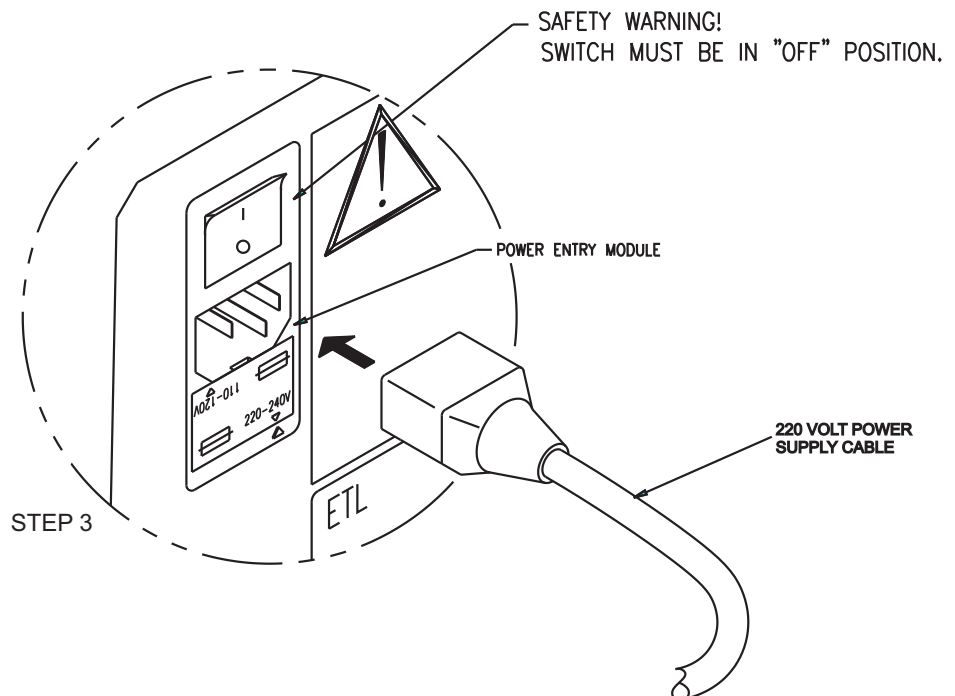

ILLUSTRATION OF THE PROPER ORIENTATION OF THE FUSE MODULE FOR OPERATION IN THE VOLTAGE RANGE OF 198 TO 264 VOLTS



1.4 MANIFOLD INSTALLATION

CAUTION: Handle the manifold carefully. The dispense and aspirate needles on the manifold are fragile.

The tubing must be connected correctly for proper functioning of the manifold. The connectors are color coded to assist in correctly connecting the manifold to the washer tubing. Connect the white dispense fittings together and the clear aspirate fittings together. Tubing should look like the illustration when it is correctly installed.

If the manifold tubing is to be replaced, see section 4.8 to properly reposition it.

Place the soaking microstrip well into the slot as shown below.

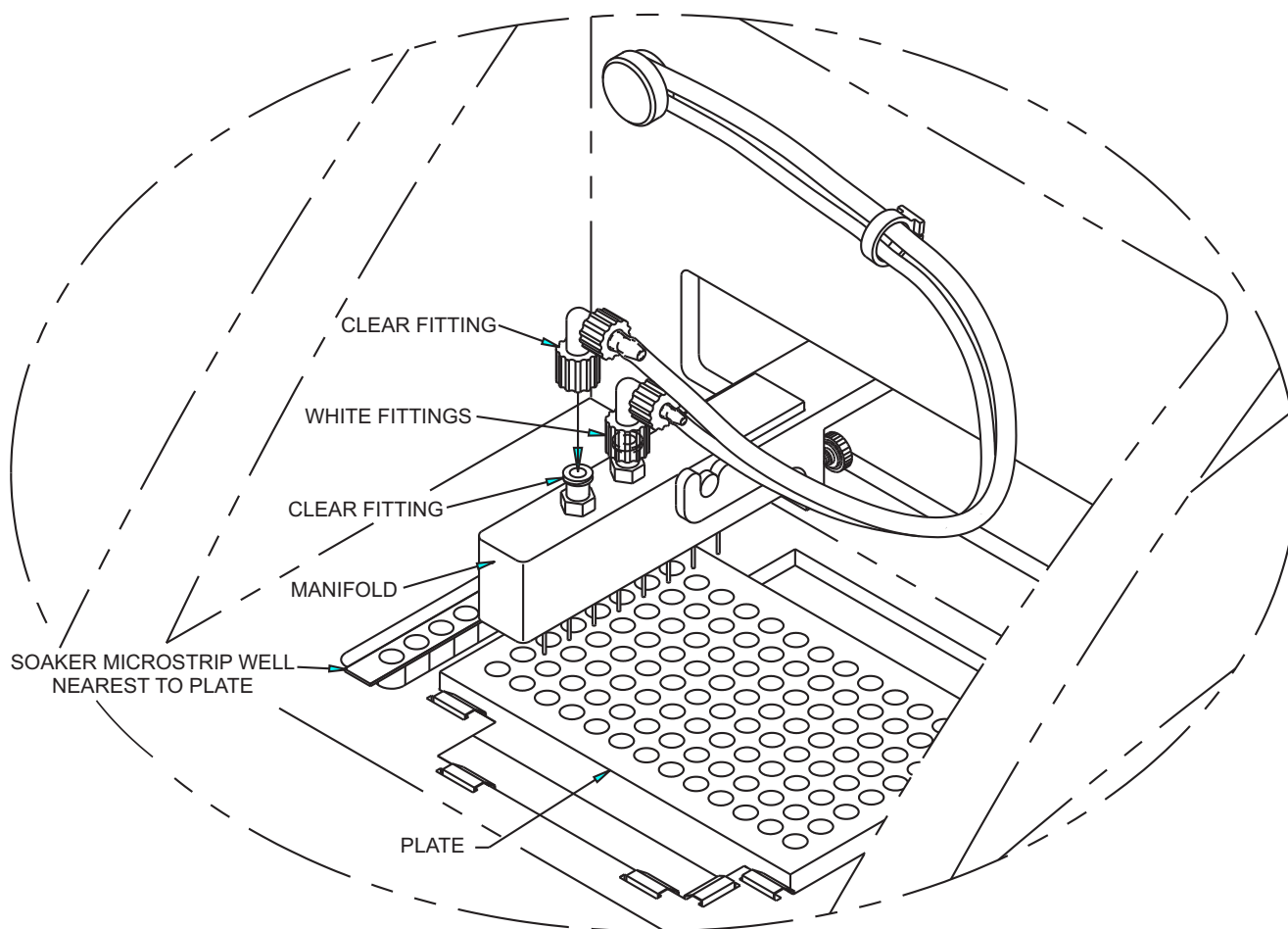

SINGLE MICROSTRIP WELL
USED WITH 8 AND 12-PORT STYLE MANIFOLDS

1.5 MANIFOLD ALIGNMENT

1.5.1 THUMBSCREW ADJUSTMENT

Adjust the thumb screw to ensure the manifold is level. (See the Figures below).

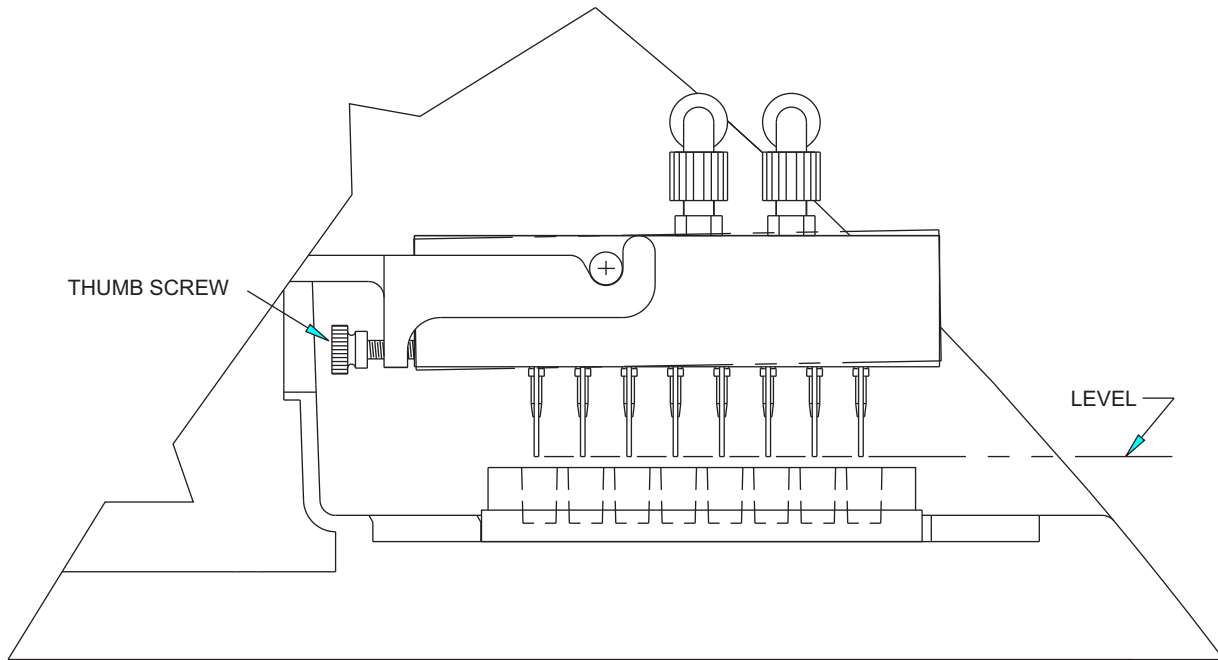

8-Port Standard Manifold Example

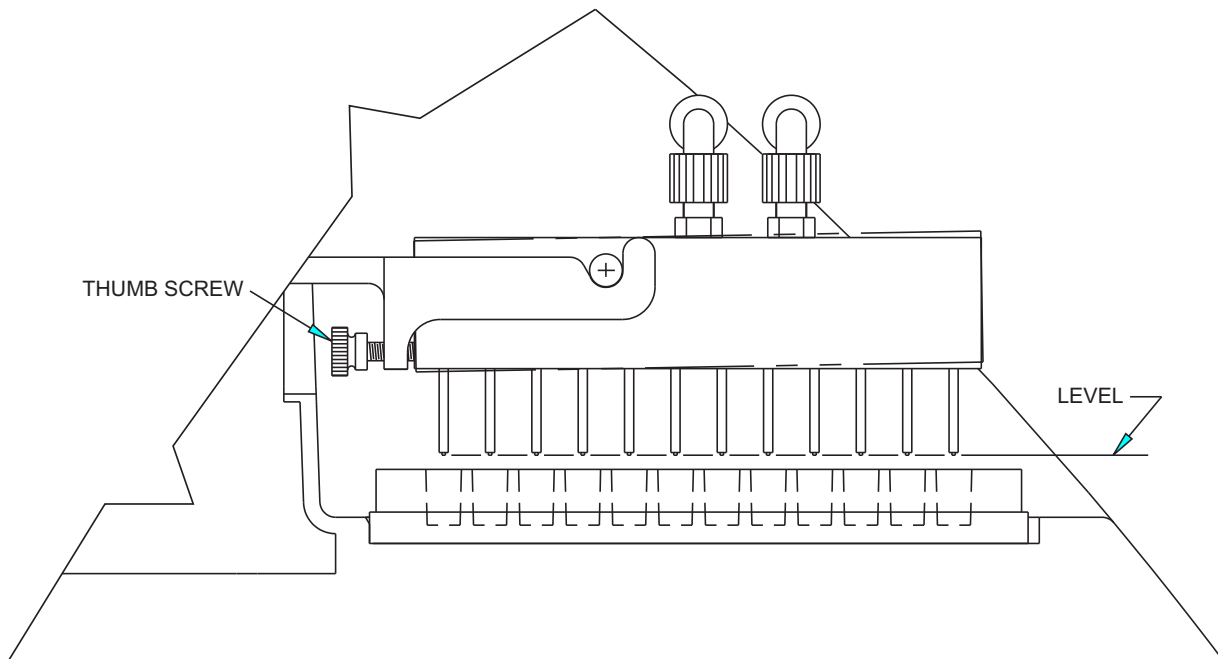



12-Port Coaxial Manifold Example

1.5.2 HORIZONTAL MANIFOLD TO MICROPLATE ADJUSTMENT



The best aspirate performance (leaving the minimum liquid in the plate wells) is obtained when the manifold aspiration needles are close to the left side wall of the well (flat bottom wells). Calibrating the manifold position can compensate for variations in microplate products from different manufacturers. Repositioning the manifold aspiration needles to the recommended .02" (.5mm) from the left-side well wall (flat bottom microplate), is completed as follows. See examples of the proper position shown on the next page for the various manifolds available.

1. Place the microplate to be used in the plate-holder. The 8 or 12 row microplate positioning must match with 8-Port or 12-Port manifold selected for use.



2. Press and hold . Press the button for about 4 seconds until the instrument beeps and shows "CAL" on the display.

3. Press . The display will show "FLA" to indicate that you are entering the horizontal adjustment mode. The horizontal adjustment is being made relative to the standard flat bottom microplate configuration. This adjustment will also change the position of the manifold for the round or V-bottom style microplate Plate Selection mode, see Section 3.3.8 for programming information.



4. Press  and the manifold will rise and move to the factory defined adjustment row as shown in the examples. The display will show the number "820". This number represents the factory default position of the manifold inside the microplate well.

5. Press  to move the manifold to the right, or  to move it to the left. Each press of the button will produce approximately .002" (.05mm) movement of the manifold to the right or left. The display will add or subtract 1 count for each press of a button. The adjustment range is ± 25 steps.

EXAMPLE: If the aspirate needles are determined to be too near the microplate well wall,

press  while observing needle positioning. If  is pressed five times, the needle will move approximately .010" (.25mm) to the right.

6. Press  to accept this setting, and to return the manifold to the soaking microstrip wells.

7. Press  again to exit the adjustment menu or press the  again to repeat the horizontal manifold adjustment routine.

8-PORT STANDARD AND
12-PORT STANDARD MANIFOLDS

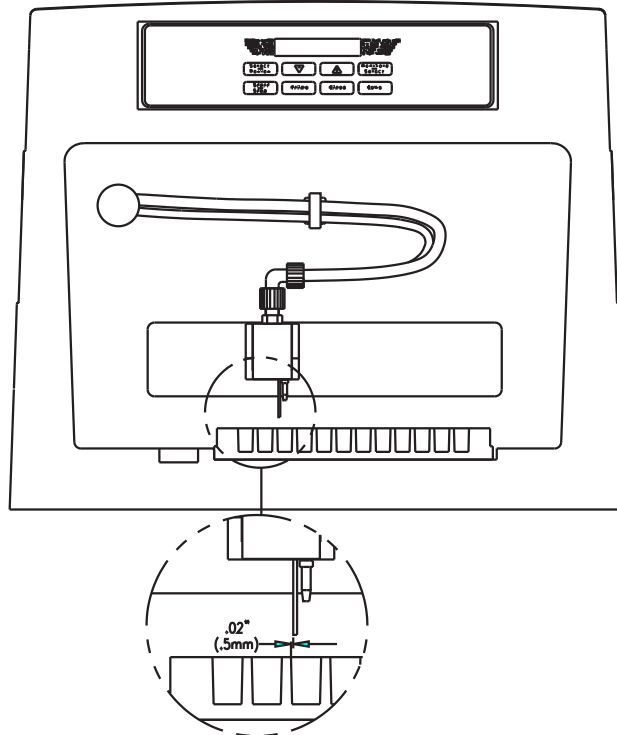

POSITION SHOWN FOR
FLAT PLATE SELECTION

8-PORT COAXIAL AND
12-PORT COAXIAL MANIFOLDS

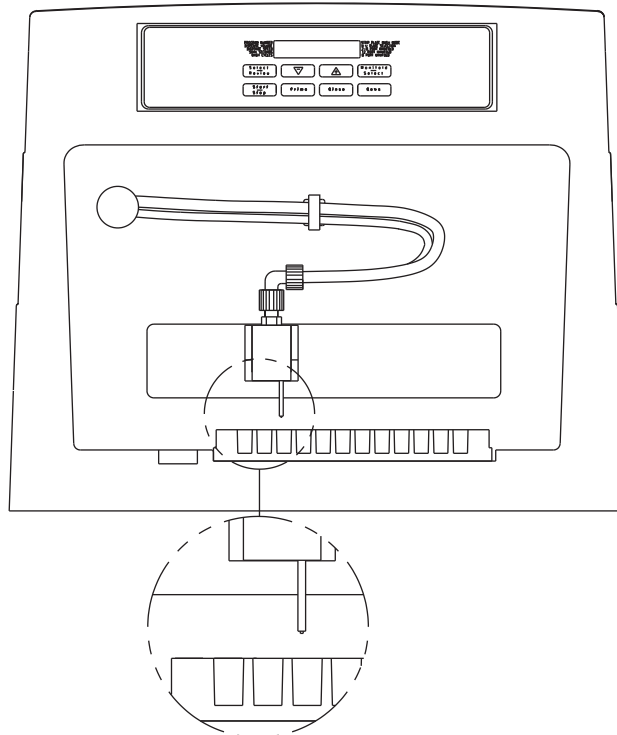

POSITION SHOWN FOR
FLAT PLATE SELECTION

1.5.3 VERTICAL MANIFOLD TO MICROPLATE ADJUSTMENT



To provide maximum flexibility in washing the microplate, the vertical aspiration position of the manifold is adjustable for well depth aspiration requirements and overflow wash applications. The factory default settings have been found to be acceptable for the majority of applications. The following steps are used to make changes within the allowed range of ± 35 steps.

1. Place the microplate to be used in the plate-holder.

2. Press and hold . Press the button for about 4 seconds until the instrument beeps and shows "CAL" on the display.

3. Press . The instrument will display "ASP" to indicate you are entering the aspiration

adjustment mode. Press  and the manifold will rise and move to the factory defined adjustment row and stop at the "Final" aspiration well depth position, as shown on the next page. The display will show "335", indicating the factory default position.

4. Press  to move the manifold up or  to move it down. Each press of the button will produce approximately .002" (.05mm) movement of the manifold up or down. The display will add or subtract 1 count for each press of a button.

Example: If the aspirate needles are determined to be too deep in the well, press 

while observing needle positioning. If  is pressed five times, the aspirate needles will move up approximately .010" (.25mm).

5. Press  to accept this setting and the manifold will then move to the "Top of Well" aspiration adjustment position, as shown on the next page. The display will show "110" indicating the factory default position. This adjustment is only required to be changed for "Bottom Wash" or "Overflow Wash" applications in special test requirements.

6. Press  to accept this setting, and return the manifold to the soaking microstrip wells.

7. Press  to return to the program operation.

“FINAL” ASPIRATION WELL POSITION

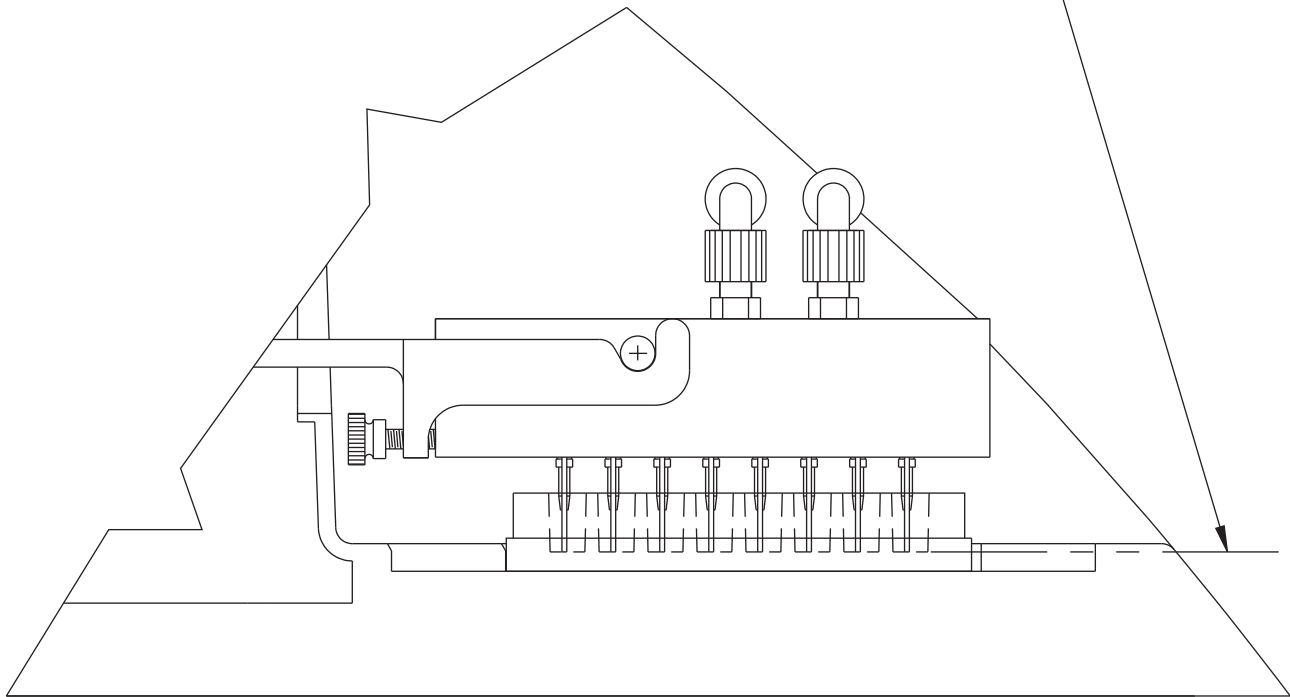

“TOP OF WELL” ASPIRATION POSITION

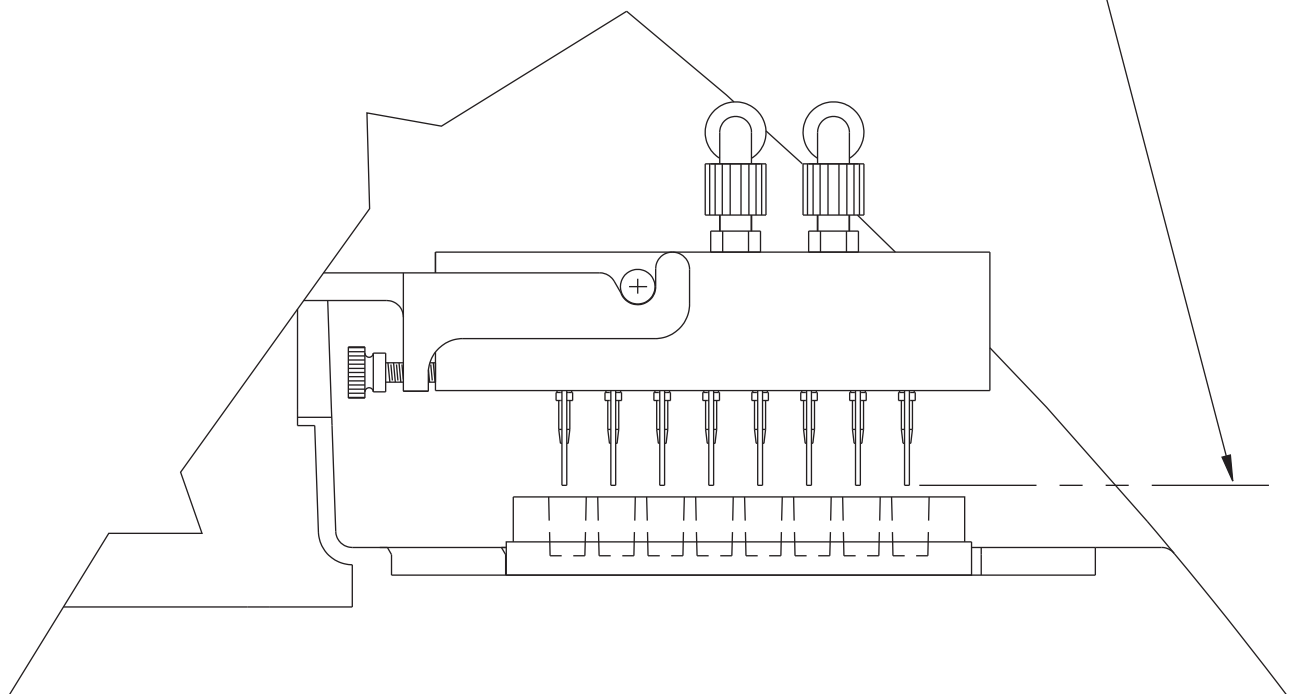

1.6 SETTING UP THE RESERVOIRS

The connectors and fittings are color coded to assist in correctly connecting the tubing for the different bottle caps. It is critical for proper fluid aspiration that the Waste cap is tight on the bottle and both green fittings are fully seated. See Section 2.3 for additional information.

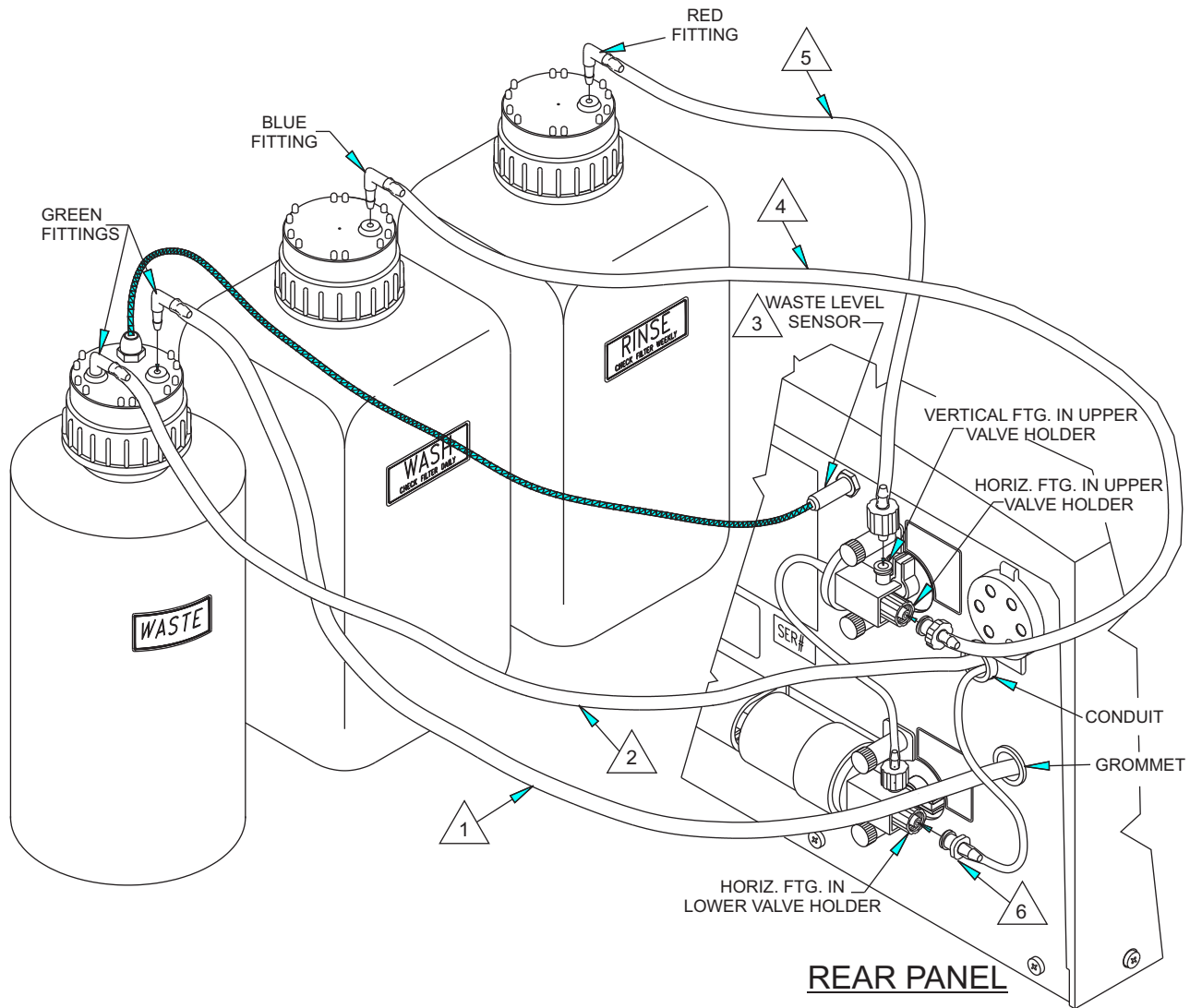

- 1 INSTALL THE GREEN FITTING ON TUBING COMING FROM THE GROMMET ON REAR PANEL, TO EITHER GREEN RECEPTACLE IN CAP OF WASTE BOTTLE.
- 2 INSTALL THE GREEN FITTING ON TUBING COMING FROM THE CONDUIT ON REAR PANEL, TO OTHER GREEN RECEPTACLE IN CAP OF WASTE BOTTLE.
- 3 INSTALL THE WASTE LEVEL SENSOR FROM THE WASTE BOTTLE, TO THE JACK AT TOP OF REAR PANEL.
- 4 INSTALL THE BLUE ELBOW FITTING ON THE END OF THE WASH TUBING INTO THE BLUE RECEPTACLE ON CAP OF WASH BOTTLE, THEN INSTALL BLUE FITTING AT OTHER END OF TUBING TO THE HORIZONTAL FITTING ON THE UPPER VALVE HOLDER.
- 5 INSTALL THE RED ELBOW FITTING ON THE END OF THE RINSE TUBING INTO THE RED RECEPTACLE ON CAP OF RINSE BOTTLE, THEN INSTALL RED FITTING AT OTHER END OF TUBING TO THE VERTICAL FITTING ON THE UPPER VALVE HOLDER.
- 6 INSTALL THE CLEAR FITTING ON THE SMALL TUBING COMING FROM THE CONDUIT ON REAR PANEL, TO THE HORIZONTAL FITTING ON THE LOWER VALVE HOLDER.

2 FUNCTIONAL DESCRIPTION

2.1 INTRODUCTION

The Multiwash III is a self-contained Multiwash III featuring keypad entry of a variety of wash parameters, including the number of rows to process and the type of plate being washed (flat-bottom, U-bottom, or V-bottom). In addition, up to 50 different Wash sequences can be entered by the user and saved as reusable programs in nonvolatile memory. The Multiwash III's positive-displacement dispense pump assures accurate, consistent plate washing, with 8-port and 12-port configurations.

To maintain the Multiwash III's reliability, the instrument performs a maintenance rinse of the soaking microstrip after eight hours of non-use. **It is important to leave the power on to the instrument at all times for this maintenance rinse function to occur. Leaving the power on is critical if the Wash solution is not routinely purged from the instrument after use.**

This rinse operation is designed to keep Wash solution from drying and leaving clogging salt deposits between uses. **It is the user's responsibility to connect the Rinse reservoir filled with distilled water to the instrument.** The maintenance rinse will continue after every eight hours of non-use.

If the Multiwash III is to be turned off, it is important to purge the Wash solution completely out of the system to prevent damage. This can be accomplished by performing the Rinse operation twice with distilled water.

2.2 DISPENSING

Wash solution is dispensed by an accurate, reliable, positive-displacement pump. The dispense sequence executes as follows:

- A valve on the syringe assembly opens the port to the Wash solution reservoir and the pump moves in the "fill" direction to draw solution into the syringe.
- When the syringe is full, the valve moves to the dispense position.
- The pump dispenses the volume of wash solution into the microplate wells called for by the wash program in use. During the wash cycle, the valve and syringe operate under program control to maintain adequate wash solution in the pump to dispense the required volume.
- Wash solution flows from the syringe through flexible tubing, into the dispense needles in the manifold, and finally into the microplate wells.
- Dispense only mode - The Multiwash III will perform an initial aspiration and then the programmed dispense volume without a final aspiration step when the number of programmed wash cycles is set to "0", zero.

2.3 ASPIRATION

Waste is aspirated from the microplate wells using an air pump, Waste reservoir, and aspirate needles. The air pump maintains a vacuum in the Waste reservoir, that is connected by flexible tubing to the aspiration needles in the manifold. As the manifold is lowered over the microplate, liquid in the microplate wells is aspirated by the vacuum in the waste reservoir and the liquid is emptied into the Waste reservoir. The rate of aspiration is such that only the very tips of the aspiration needles make contact with the liquid, thereby minimizing carry-over from row-to-row. A liquid level sensor in the Waste reservoir signals the Multiwash III when the Waste reservoir is nearly full. When liquid has reached the level sensor, the Waste reservoir must be emptied before the Multiwash III will begin a new wash cycle.

The Multiwash III will display "FUL" and will not run until the Waste reservoir is emptied.

- Aspirate only Mode - The Multiwash III will perform an aspiration only operation when the programmed Dispense Volume is set to "0", zero and the number of Wash Cycles is set to "1".

2.4 Wash Cycle OPTIONS



The Multiwash III provides two different types of wash cycles designated **STRIP WASH MODE** and **PLATE WASH MODE**.

STRIP WASH MODE is used for "short soak" or "strip wash" cycle requirements. This mode soaks each row as it is washed, before moving on to the next row, and is typically used when the soak times are short (0-80 seconds). STRIP WASH MODE begins by moving to row 1 and aspirating any liquid that is in the microplate wells. The instrument then dispenses wash solution into row 1, lets the row soak for the user-entered SOAK SECONDS, and then aspirates the wash solution from the wells. The dispense/soak/aspirate operation is repeated for the number of CYCLES entered. Each row of the microplate is washed in turn, until the number of ROWS specified have been washed. While soaking, the display shows the remaining soak time. The instrument must not be disturbed during the soak unless the wash is to be cancelled. See Section 3.1.1 for additional information.

PLATE WASH MODE is used for "long soak" or "plate wash" cycle requirements. This mode allows a row to soak while subsequent rows are being washed, and is typically used when longer (up to 999 seconds) soak times are required. PLATE WASH MODE begins by moving to row 1 and aspirating any liquid in that row of microplate wells. The instrument then dispenses wash solution into row 1, and moves to the next row, leaving wash solution in row 1 to soak. This sequence is repeated for each row until the number of ROWS selected has been processed. The instrument then returns the manifold to the soaking microstrip position until the SOAK SECONDS for the first row has elapsed. The aspirate and dispense is then repeated across the microplate, completing the first wash cycle. This sequence of passes across the microplate is repeated for the number of CYCLES selected. At the end of the last cycle, wash solution is aspirated from the wells. All rows are soaked for the same length of time. Each row is left with wash solution to soak for the designated SOAK SECONDS. The minimum soak time, is determined by the amount of time it takes the Multiwash III to fill the number of rows with the dispense volume selected. While soaking, the display shows the remaining soak time. The instrument must not be disturbed during the soak unless the wash is to be cancelled. See Section 3.1.2 for additional information



2.5 KEYPAD

The Multiwash III keypad has eight buttons with which the user sets up and controls the operation of the instrument. The buttons are:

SELECT/REVIEW	Used to select the parameter the user wants to change or review.
	Used to decrease the value of the selected parameter.
	Used to increase the value of the selected parameter.
MANIFOLD/SELECT	Used to select the manifold configuration installed.
START/STOP	Press to start a wash cycle or to stop a wash cycle in progress.
PRIME	Press to start the PRIME cycle.
RINSE	Press to start the RINSE cycle.
ROWS	Used to select the number of ROWS to be washed.

2.6 DISPLAY

The display on the front of the Multiwash III indicates the current setting of selected parameters and, during washes, indicates status. Arrows at the left edges of the display indicate the currently selected parameter. For example, when the arrow next to the "DISPENSE VOLUME" label on the front panel is visible, the current dispense volume setting

is displayed and can be changed, using the  and  buttons.

Arrows at the right edge of the display indicate which wash mode setting (see Section 3.3.7) is selected, whether the instrument is set for flat bottom or U-/V-bottom microplates (see Section 3.3.8) and whether the instrument is set for an 8-port manifold or 12-port manifold.

During Prime, "**Pri**" is displayed to indicate the instrument is completing the prime routine.

During soak times, the remaining soak time is displayed.

During Rinse, "**rin**" is displayed to indicate the instrument is completing the rinse routine. To indicate completion of a wash. The display flashes "---" for approximately 10 seconds and then the instrument beeps twice.

The display will show "FUL" when the Start/Stop key is pushed and the Waste reservoir is full. Empty the Waste reservoir and the instrument will then begin a wash cycle when the Start/Stop key is pushed.

The display will show error codes when there is a problem with the instrument and stop working. Your distributor should be contacted for additional assistance (see Appendix 2) and the troubleshooting guide in Section 5.2 and the error code table in Section 5.3 gives additional assistance.

2.7 AUTORINSE VALVE

During the Wash and Prime modes, the AutoRinse valve is positioned to use the Wash solution. There is no movement of the AutoRinse valve when the instrument is switched between the Wash and Prime modes. The AutoRinse valve operates only after the Rinse button has been pushed or after 8 hours of non-use. The instrument is designed for the AutoRinse valve to automatically switch to the Rinse Reservoir position and the Multiwash III to flush the lines of Wash solution after 8 hours of non-use. The soaking microstrip is then refilled from the Rinse Reservoir. The Multiwash III instrument will then continue to aspirate and refill the soaking microstrip every 8 hours from the Rinse Reservoir. When the Start/Stop button is pushed to use the Multiwash III again, the AutoRinse valve will then rotate back into the Wash solution position. The instrument will first go through the Prime cycle to flush the lines of the Rinse solution, then begin the Wash sequence.

3 OPERATION

3.1 OVERVIEW

3.1.1 STRIP WASH MODE

This mode soaks each row as it is ashed, before moving on to the next row, and is typically used when the oak times are short (0 - 80 seconds).



STRIP WASH MODE begins by moving to row 1 and aspirating any liquid that is in the microplate wells. The instrument then dispenses wash solution into row 1, lets the row soak for the entered SOAK SECONDS, and then aspirates the wash solution from the wells. The dispense/soak/aspirate operation is repeated for the number of CYCLES entered. Each row of the microplate is washed in turn, until the number of ROWS specified have been washed. When soaking, the display shows the remaining soak time. Don't disturb the instrument unless you wish to cancel the wash.

3.1.2 PLATE WASH MODE

This mode allows a row to soak while subsequent rows are being washed, and used when longer (up to 999 seconds) oak times are required. The shortest oak time is typically 80 seconds for 12 rows.

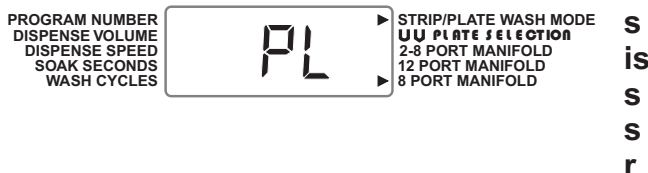

PLATE WASH MODE begins by moving to row 1 and aspirating any liquid that is in that row of microplate wells. The instrument then dispenses wash solution into row 1, and moves to the next row, leaving wash solution in row 1 to soak. This sequence is repeated for each row until the number of ROWS selected have been processed. The instrument then returns the manifold to the standby row until the SOAK SECONDS for the first row has elapsed. The aspirate and dispense is then repeated across the microplate, completing the first wash CYCLE. This sequence of passes across the microplate is repeated for the number of CYCLES selected. At the end of the last CYCLE, wash solution is aspirated from the wells. All rows are soaked for the same length of time. Each row is left with wash solution to soak for the designated SOAK SECONDS. The minimum soak time is determined by the number of rows and the dispense volume selected. The maximum SOAK SECONDS is 999 seconds. When soaking, the display shows the remaining soak time. Don't disturb the instrument unless you wish to cancel the wash.

3.1.3 PRIME

Priming the plate washer will prepare it for operation by filling the dispense pump, tubing and manifold with liquid and removing air from the system. Prime is used when the instrument is first set up, fluid reservoirs have been changed, the dispense module or manifold has been changed, or when performing a distilled water rinse from the Rinse reservoir. See section 6.1 for Prime Cycle volume usage.

Press  to start. Press  to cancel. During priming, the display will show "Pri".

3.1.4 RINSE

The plate washer should be rinsed daily after use. The Rinse uses distilled water to purge the syringe, tubing and manifold of wash solutions. See Section 6.1 for Rinse cycle volume usage.

Press  to start. Press  to cancel. During rinsing, the display will show "rin".

3.1.5 ROWS

The ROWS key allows the operator to select the desired number of rows on the microplate to be processed. Twelve rows is the maximum number when using an 8-port manifold. Eight rows is the maximum number when using a 12-port manifold. Twelve rows, changing only in increments of 2 rows, is the maximum number when using a 2-8-port manifold.

Press  to initiate setting. Then use the  or  key to select the number of rows.

Press  to return to menu. When  is pressed, the number of rows selected will be displayed.

3.1.6 AUTOMATIC STANDBY-ROW REFILL

If the power to the instrument is left on, the liquid in the standby row will automatically be aspirated and refilled every 8 hours to prevent the manifold needles from drying out.

To maintain the Multiwash III's reliability, the instrument performs a maintenance rinse of the standby row after eight hours of non-use. **It is important to leave the power on to the instrument at all times for this maintenance rinse function to occur. Leaving the power on is critical if the Wash solution is not routinely purged from the instrument after use.** This rinse operation is designed to keep Wash solution from drying and leaving clogging salt deposits between uses. **It is the user's responsibility to connect the Rinse reservoir filled with distilled water to the instrument.** The maintenance rinse will continue after every eight hours of non-use.

If the Multiwash III is to be turned off, it is important to purge the Wash solution completely out of the system to prevent damage. This can be accomplished by performing the Rinse operation twice with distilled water.

3.1.7 WASTE RESERVOIR FULL SENSOR

When the liquid in the Waste reservoir covers the end of the sensor probe, the instrument will



beep and display "FUL" when  is pressed to begin a plate wash. Empty the Waste reservoir. The waste sensor must be plugged into the jack on the rear panel before a plate wash can begin.

NOTE: It is also recommended that the Wash reservoir be refilled at this time.

3.2 OPERATING INSTRUCTIONS SUMMARY

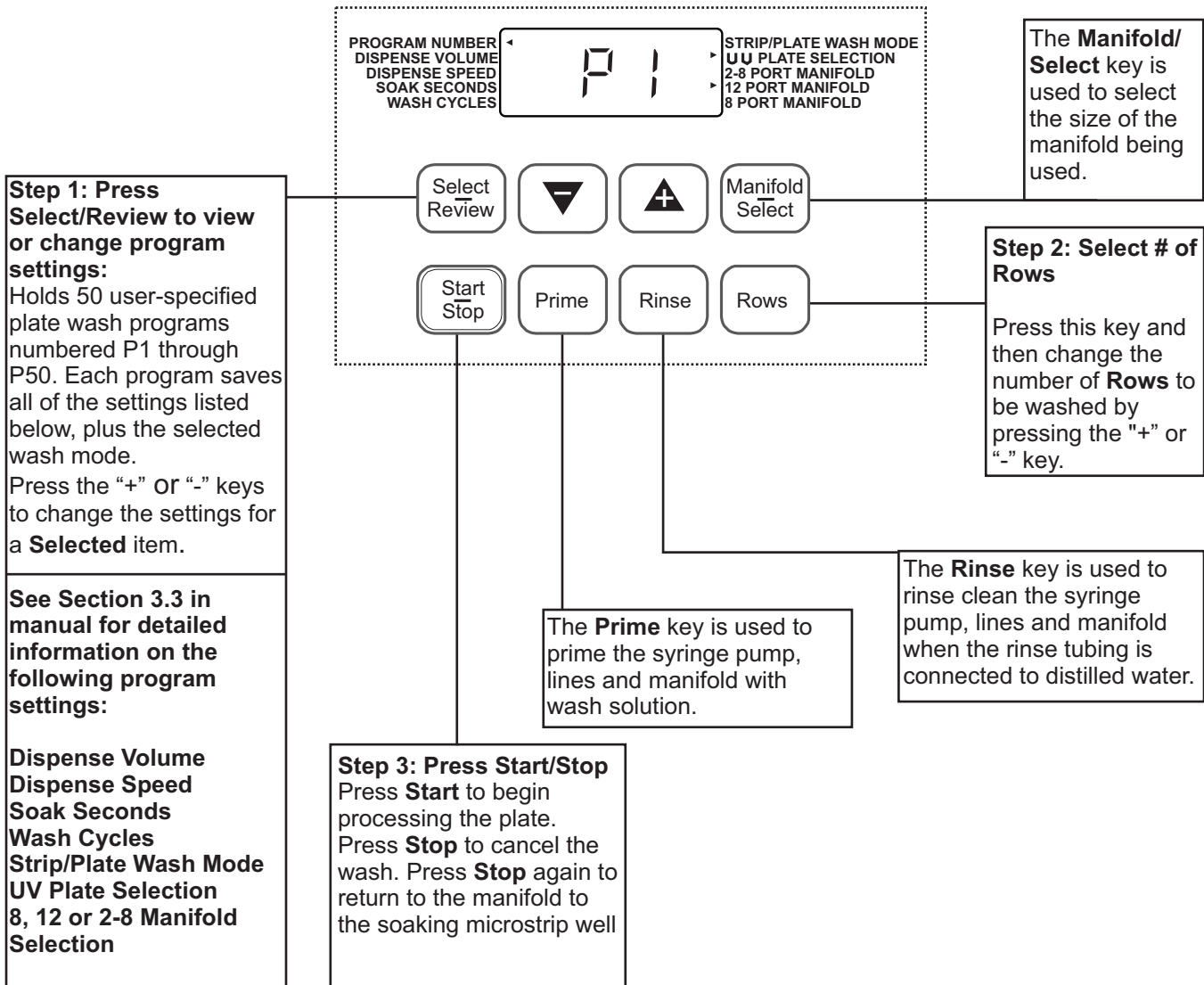
See instructions for fuse module installation, setting up the reservoirs, and installing the manifold tubing in Section 1.



When changing settings by a large amount, holding down the  or  keys will speed your entry.



3.3 PROGRAMMING A WASH CYCLE

3.3.1 PROGRAM NUMBER

The instrument will save up to 50 user-entered wash sequences in "programs",





numbered 1 through 50. Press  until the flashing arrow appears next to PROGRAM

NUMBER. The display will show the current program number. Press  or  to change to another program. Any entries for Dispense Volume, Dispense Speed, Soak Seconds, Wash Cycles, Strip/Plate Wash Mode, and plate type will be saved in this program number.

3.3.2 MANIFOLD/SELECT

Press  and the currently selected manifold for the program will be displayed. If the manifold selection is changed, then all of the following programmed values should be





reviewed before running the program. Press the  or  to move between "8", "12" or "2-8" port manifold. The display will show which manifold has been selected. The maximum value of rows will change to 8 rows when the 12-port manifold is displayed.

WARNING: THE 2-8 PORT MANIFOLD OPTION IS NO LONGER AVAILABLE. SELECTING THIS OPTION WILL CAUSE THE WASHER TO SKIP ROWS FOR THE STANDARD 8-PORT MANIFOLD.

3.3.3 DISPENSE VOLUME

Press  until the flashing arrow appears next to DISPENSE VOLUME and the volume is



displayed. Adjust the dispense volume by pressing  or  in 10 µl increments. The display shows the per-well volume, regardless of 8, 12 or 2-8-port manifold selection. Maximum volume is dependent on the manifold selected, see Section 6.1 for additional information.

3.3.3.1 TO ASPIRATE ONLY

A) Set the DISPENSE VOLUME to zero.





B) The number of WASH CYCLES must be adjusted to **greater** than zero. The washer will then aspirate the fluid and will not dispense any liquid into the wells.



Multiwash III

3.3.4 DISPENSE SPEED

Press  until the flashing arrow appears next to DISPENSE SPEED. Press



the  and  keys to adjust the initial speed up and down.

The DISPENSE SPEED is the rate at which the liquid will be dispensed from an individual manifold needle. The DISPENSE SPEED requirement will vary depending on the application. For an 8-port manifold, the range is 150 µl/sec to 500 µl/sec and for the 12-port it is 150 µl/sec to 400 µl/sec.



3.3.5 SOAK SECONDS



Press  until the flashing arrow appears next to SOAK SECONDS and the soak time is displayed. Set the soak time by pressing

 or . Maximum soak time is 999 seconds.



3.3.6 WASH CYCLES

Press  until the flashing arrow appears next to WASH CYCLES and the number of

cycles is displayed. Set the number of wash cycles by pressing  or . Maximum number of cycles is 10.





3.3.6.1 TO DISPENSE ONLY

Set WASH CYCLES to 0, then the total volume will be dispensed into each well without aspiration.

3.3.7 STRIP/PLATE MODE WASH

Press  until the flashing arrow appears next to STRIP/PLATE MODE WASH.



Press  or  to toggle between "SP" = STRIP or "PL" = PLATE wash modes. When "PL", PLATE WASH MODE is selected, the arrow will remain displayed as a visual reminder that Plate Wash mode has been selected for this program.



3.3.8 U/V PLATE SELECTION

Press  until the flashing arrow appears next to UV PLATE SELECTION and the plate



selection is displayed. Press  or  to toggle between "FL" or "rnd". Flat bottom wells are best aspirated with the aspiration needles very close to the left edge of the wells (see manifold calibration in section 1.5.2). Round, U-shaped and V-shaped bottom microplates are best aspirated with the aspiration needles on the centers of the wells. When "rnd" mode is selected, the instrument automatically repositions the manifold aspiration needles closer to the center of the wells for round, U and V style plates. The indicator arrow will remain displayed as a visual reminder that "rnd" UV PLATE mode has been selected for this program.



3.3.9 ROWS

Press  to display the number of rows selected. Set the number of rows, 1 up to 12 (8 port manifold), 1 up to 8 (12 port manifold) or 2 up to 12 in increments of 2 (2-8 port



manifold) by pressing  or . Press  and the display will show PROGRAM NUMBER again.

3.3.10 START/STOP

Press  to start the current wash program. Press  again to cancel the plate processing and stop the manifold at the last wash position.

Press  again and the manifold will return to the soaking microstrip wells.

Multiwash III

3.3.11 USER DEFINED PROGRAM LOG SHEET

These two pages are provided for logging the Multiwash III settings for reference.

Program # _____	Used for _____
Dispense Volume _____	Wash Mode _____
Dispense Speed _____	Plate Selection _____
Soak Seconds _____	Manifold Selection _____
Wash Cycles _____	

Program # _____	Used for _____
Dispense Volume _____	Wash Mode _____
Dispense Speed _____	Plate Selection _____
Soak Seconds _____	Manifold Selection _____
Wash Cycles _____	

Program # _____	Used for _____
Dispense Volume _____	Wash Mode _____
Dispense Speed _____	Plate Selection _____
Soak Seconds _____	Manifold Selection _____
Wash Cycles _____	

Program # _____	Used for _____
Dispense Volume _____	Wash Mode _____
Dispense Speed _____	Plate Selection _____
Soak Seconds _____	Manifold Selection _____
Wash Cycles _____	

Program # _____ Used for _____
Dispense Volume _____ Wash Mode _____
Dispense Speed _____ Plate Selection _____
Soak Seconds _____ Manifold Selection _____
Wash Cycles _____

Program # _____ Used for _____
Dispense Volume _____ Wash Mode _____
Dispense Speed _____ Plate Selection _____
Soak Seconds _____ Manifold Selection _____
Wash Cycles _____

Program # _____ Used for _____
Dispense Volume _____ Wash Mode _____
Dispense Speed _____ Plate Selection _____
Soak Seconds _____ Manifold Selection _____
Wash Cycles _____

Program # _____ Used for _____
Dispense Volume _____ Wash Mode _____
Dispense Speed _____ Plate Selection _____
Soak Seconds _____ Manifold Selection _____
Wash Cycles _____

Program # _____ Used for _____
Dispense Volume _____ Wash Mode _____
Dispense Speed _____ Plate Selection _____
Soak Seconds _____ Manifold Selection _____
Wash Cycles _____

4 MAINTENANCE

4.1 GENERAL

The life expectancy of the liquid handling components in any equipment that contact saline solutions depends largely upon operator care. Allowing the wash solution in the manifold, tubing or dispense pump to dry out will create problems. The salt deposits left by the dried wash solution can easily clog the system. This instrument is designed to help prevent clogging or dried salt deposits by keeping its components wet (as long as the power is left on, and its Rinse reservoir is connected and full). When not in use, the system should be rinsed twice with distilled water. The AutoRinse valve will switch to the Rinse reservoir automatically when the power is left on.

4.2 MAINTENANCE SCHEDULE AND SERVICE RECORD

See pages 23 and 24 for suggested maintenance schedule and sample service records.

4.3 INLET LINE FILTERS—WASH AND RINSE RESERVOIRS

It is recommended that the inlet line filters in both the Wash and Rinse reservoirs be back-flushed at least once every week if wash solution is left standing in the bottle for long periods of time. This removes trapped particles and prevents excessive back pressure on the dispense pump and syringe assembly. The filters can be removed from the inlet tubings and a syringe filled with an appropriate rinse solution such as distilled water can be used to backflush the filters. Do not rinse with strong acids or solvents.

4.4 ASPIRATE EXHAUST FILTER

The exhaust filter material (two ordinary cotton balls) should be replaced periodically, depending on the amount of use. Open the exhaust cap on the rear panel, and replace as needed.

4.5 DISPENSE PUMP AND SYRINGE ASSEMBLY ON BACK PANEL

Rinsing twice with distilled water is required, before turning instrument off.

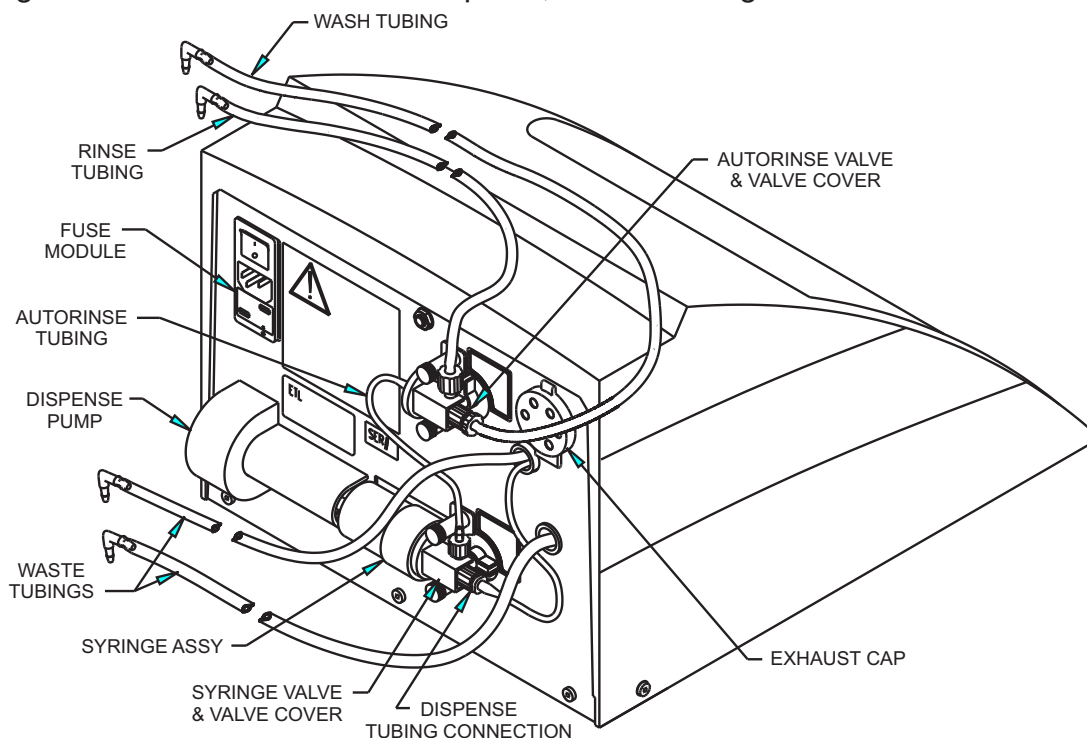

MODEL _____ SERIAL # _____	INSTITUTION _____												MONTH / YEAR _____																				
MAINTENANCE REQUIREMENT																																	
DATE	1	2	3	4	5	6	7	8	9	10	11	12	13	14	15	16	17	17	19	20	21	22	23	24	25	26	27	28	29	30	31		
START OF DAY																																	
FILL WASH RESERVOIR																																	
PRIME TO REMOVE BUBBLES																																	
CHECK DISP./ASP. PROBES																																	
CLEAN PROBES IF NEEDED																																	
END OF DAY																																	
FILL RINSE RESERVOIR																																	
RINSE CYCLE TO FLUSH LINES																																	
ADD 10% BLEACH TO WASTE/EMPTY																																	
EMPTY WASH RESERVOIR																																	
WEEKLY																																	
BACKFLUSH RESERVOIR FILTERS																																	
MONTHLY																																	
DECONTAMINATE WITH BLEACH																																	
REPLACE EXHAUST FILTER																																	

Call TriContinent if equipment malfunctions

Multiwash III

MODEL SERIAL # _____	INSTITUTION _____												MONTH / YEAR _____																				
MAINTENANCE REQUIREMENT																																	
DATE	1	2	3	4	5	6	7	8	9	10	11	12	13	14	15	16	17	17	19	20	21	22	23	24	25	26	27	28	29	30	31		
START OF DAY																																	
FILL WASH RESERVOIR																																	
PRIME TO REMOVE BUBBLES																																	
CHECK DISP./ASP. PROBES																																	
CLEAN PROBES IF NEEDED																																	
END OF DAY																																	
FILL RINSE RESERVOIR																																	
RINSE CYCLE TO FLUSH LINES																																	
ADD 10% BLEACH TO WASTE/EMPTY																																	
EMPTY WASH RESERVOIR																																	
WEEKLY																																	
BACKFLUSH RESERVOIR FILTERS																																	
MONTHLY																																	
DECONTAMINATE WITH BLEACH																																	
REPLACE EXHAUST FILTER																																	

Call TriContinent if equipment malfunctions

4.6 CLEANING MANIFOLD NEEDLES

A needle cleaning wire is supplied with each manifold, and may be used to unclog aspirate or dispense needles which have been plugged by particulates or dried salt deposits. The standard manifold dispense needles are a composite assembly with an outside sheath of plastic, housing an inner precision bore glass capillary tube. Avoid bending the assembly when handling. The cleaning wire can be used when rinsing fails to clear a bore.

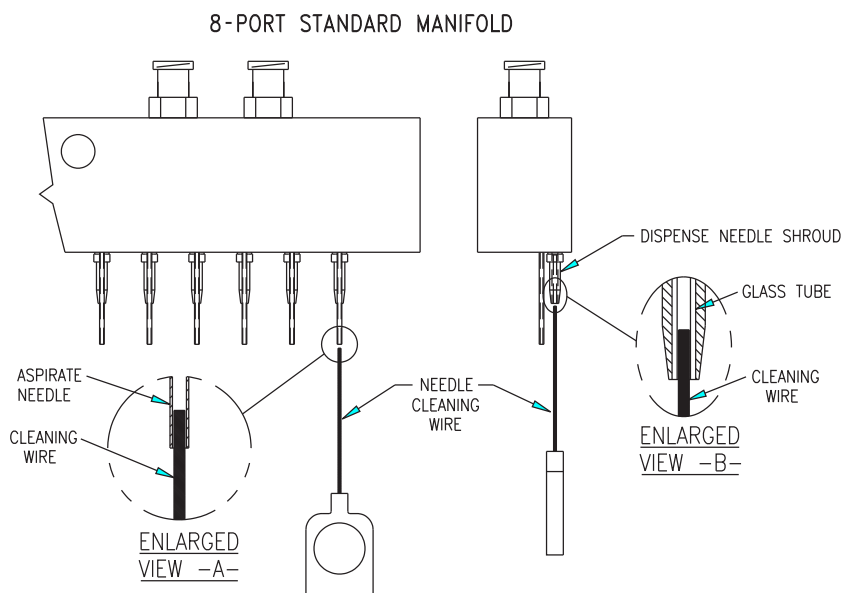

1 ENLARGED VIEW -A- SHOWS CLEANING WIRE ENTERING THE ASPIRATE NEEDLES.

2 ENLARGED VIEW -B- SHOWS CLEANING WIRE ENTERING THE GLASS TUBE INSIDE THE DISPENSE SHROUD.

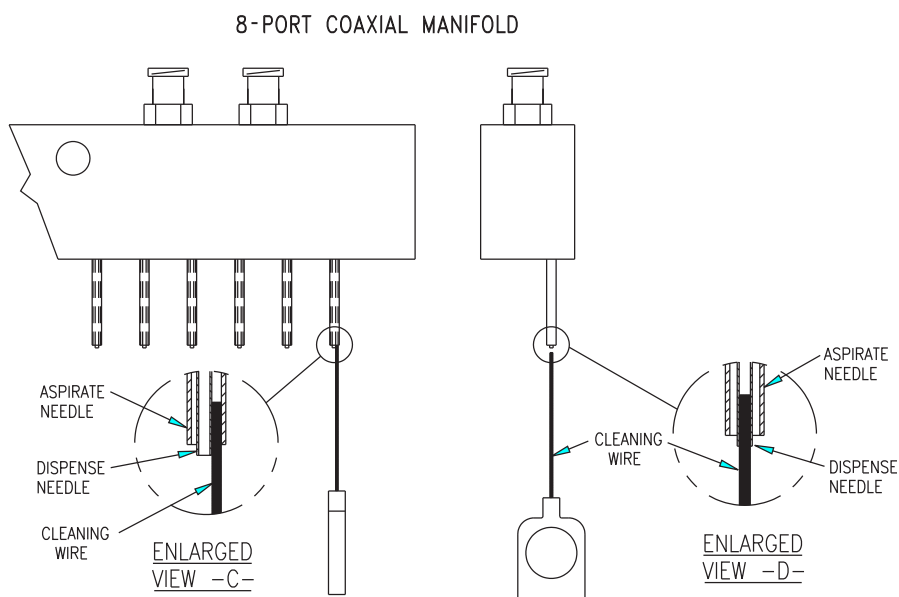

1 ENLARGED VIEW -C- SHOWS CLEANING WIRE ENTERING THE ASPIRATE NEEDLES.

2 ENLARGED VIEW -D- SHOWS CLEANING WIRE ENTERING THE DISPENSE NEEDLES.

4.7 REPLACING STANDARD MANIFOLD DISPENSE NEEDLES

Note: A needle service tool—included with the optional Maintenance Kit and in the Replacement Needle Kit—is required to replace manifold dispense needles. Insert the needle service tool under the dispense needle collar. Pry the dispense needle upward with the tool. This will loosen the needle from its press fit with the manifold. Place the new needle into the open end of the needle service tool and firmly insert it into the manifold. **Care should be exercised to prevent breakage of the precision glass insert.**

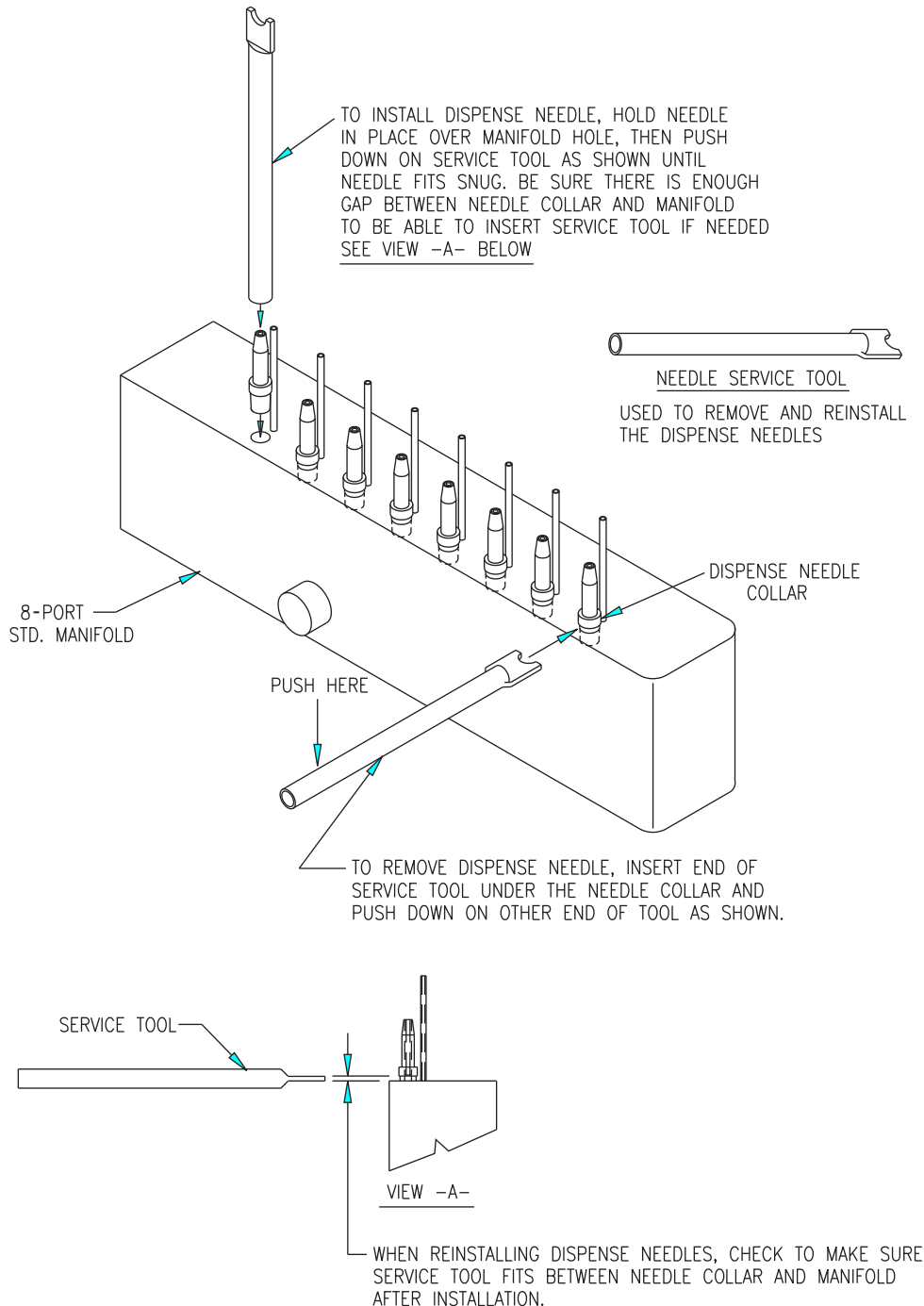

4.8 INSTALLING MANIFOLD TUBING

Use these step-by-step instructions to install the tubing for proper functioning of the manifold, remembering that the dispense and aspirate needles on the manifold are fragile.

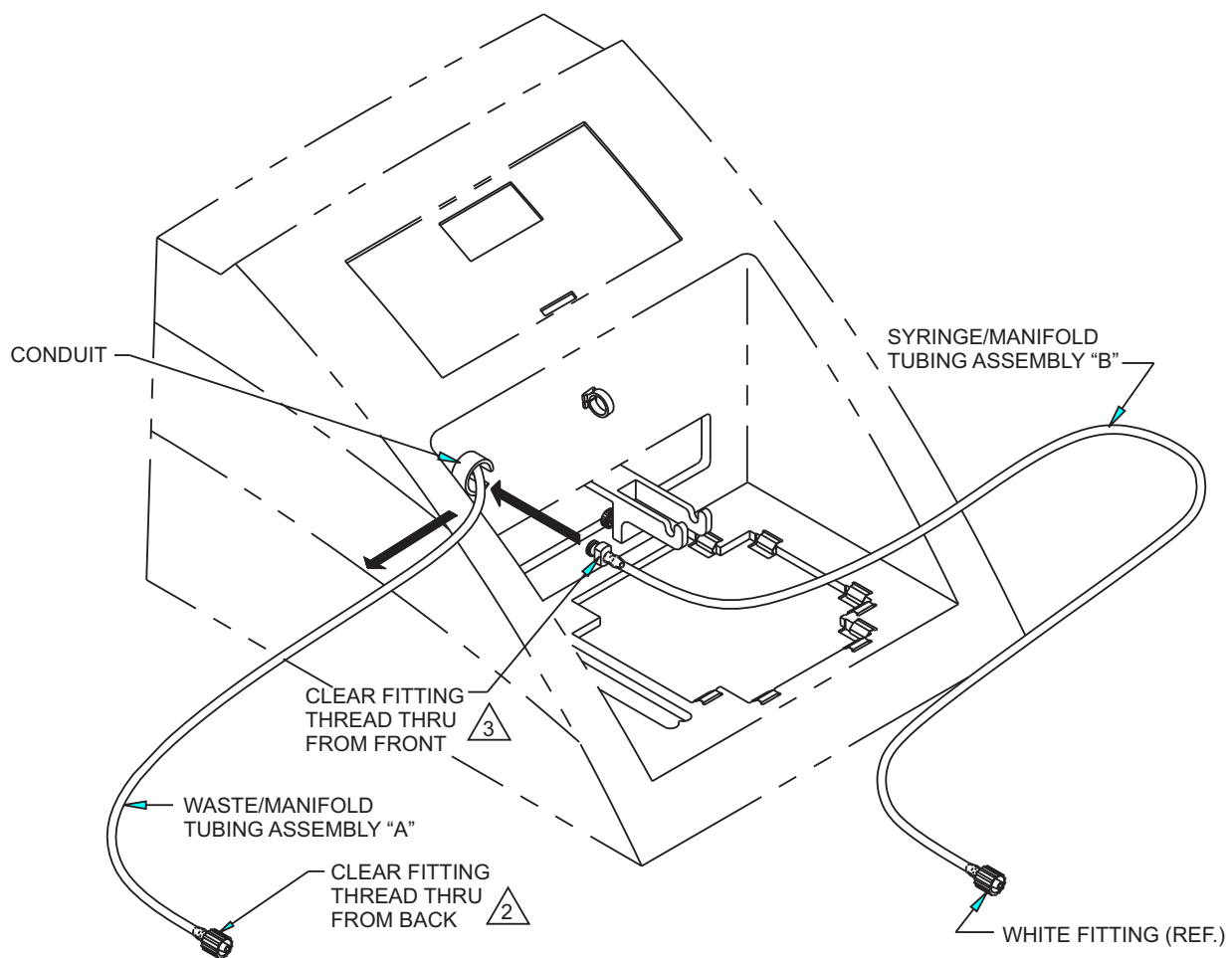

1. IDENTIFY EXISTING OR NEW TUBING, WASTE/MANIFOLD ASSEMBLY "A" AND TUBING SYRINGE/MANIFOLD ASSEMBLY "B" AS SHOWN ABOVE.

2. THREAD THE CLEAR FITTING ON TUBING ASSEMBLY "A", THRU THE CONDUIT FROM THE REAR OF THE UNIT AS SHOWN.

3. THREAD THE CLEAR FITTING ON TUBING ASSEMBLY "B", THRU THE CONDUIT FROM THE FRONT OF THE UNIT AS SHOWN.

(continued on next page)

4.8 INSTALLING MANIFOLD TUBING (continued)

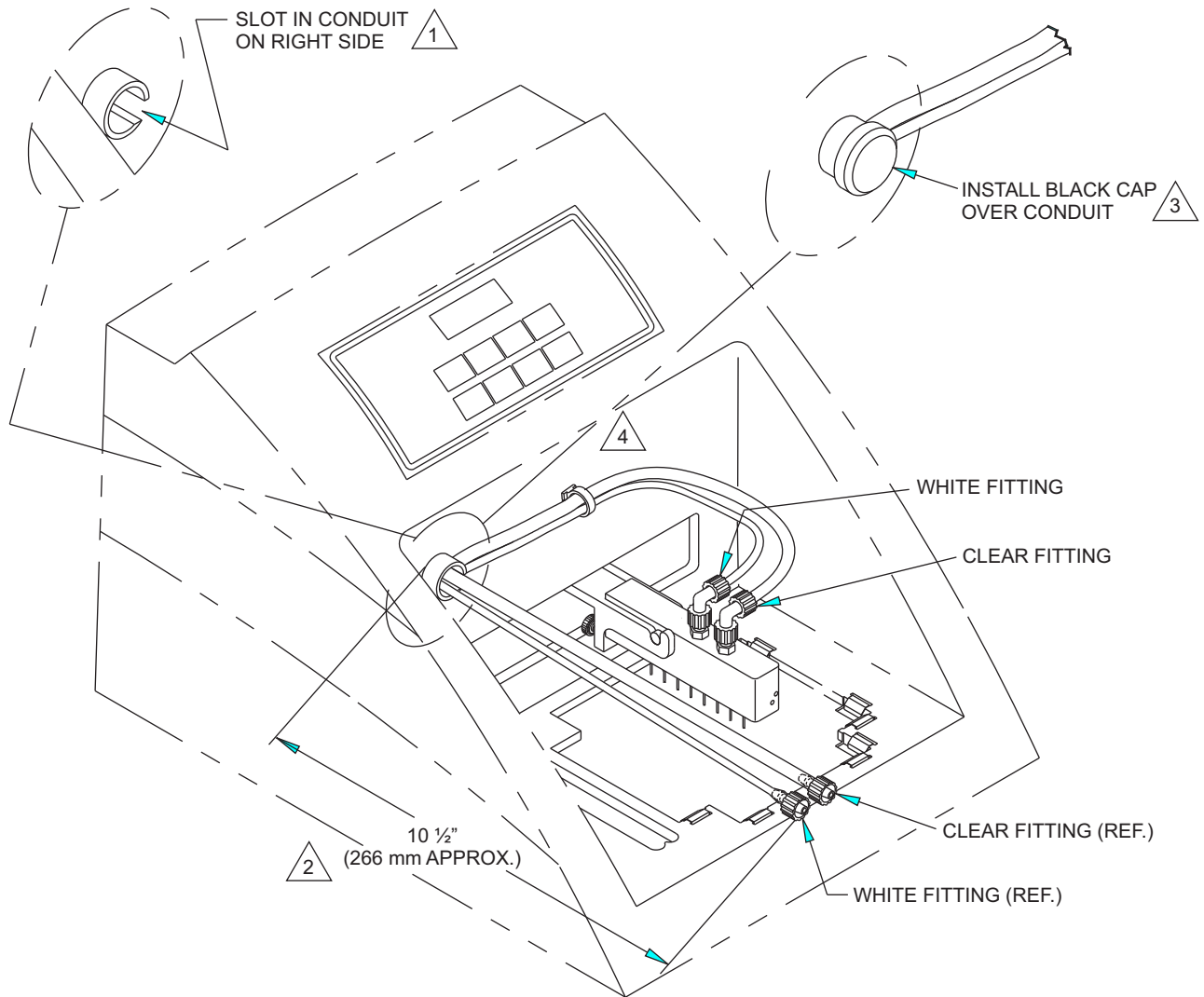

- 1 TURN THE CONDUIT SO THE TUBING RELIEF SLOT IS AT THE RIGHT SIDE WHEN VIEWED FROM THE FRONT OF THE CASE.
- 2 MEASURE TO 1/2" OF TUBING FROM THE FRONT OF THE CASE TO THE END OF THE LUER FITTING AS SHOWN ABOVE.
- 3 INSTALL THE BLACK CAP TO CLOSE OFF THE FRONT END OF THE CONDUIT.
- 4 THREAD BOTH LUER FITTINGS THROUGH THE TUBING CLIP.

4.9 FUSE MODULE REMOVAL AND FUSE INSTALLATION INSTRUCTIONS

(BOTH FUSES MUST BE INSTALLED FOR PROPER OPERATION.)

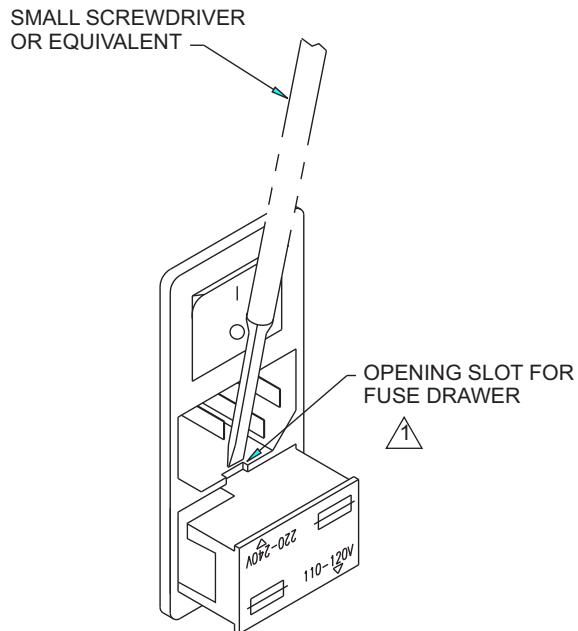

FRONT VIEW OF POWER MODULE SHOWING FUSE DRAWER REMOVAL

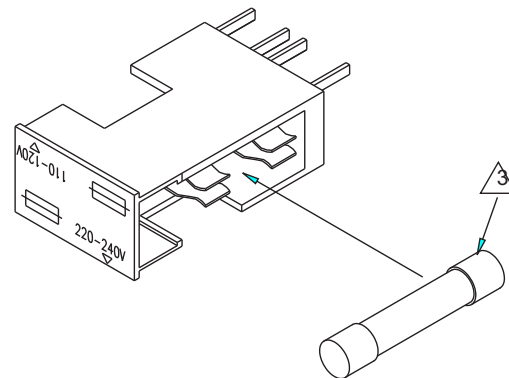

LOOKING AT FRONT/RIGHT SIDE OF FUSE DRAWER WITH 220-240V WORDING AT THE BOTTOM

1. REMOVE FUSE DRAWER USING A SMALL SCREW DRIVER OR EQUIVALENT BY PRYING AT THE SLOT AT THE TOP MIDDLE OF FUSE DRAWER AS SHOWN.

3. INSTALL A 375mA FUSE INTO FUSE CLIPS AT RIGHT SIDE OF FUSE DRAWER AS SHOWN.

2. TEMPORARILY PLACE FUSE DRAWER ON BENCH.

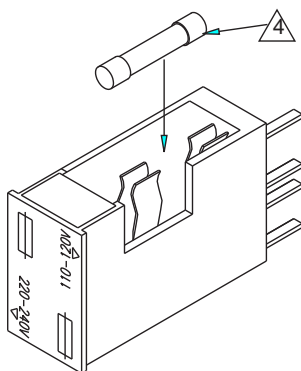

LOOKING AT FRONT/RIGHT SIDE OF FUSE DRAWER WITH 110-120V WORDING AT TOP RIGHT

4. INSTALL A 160mA FUSE TO OTHER SIDE OF FUSE DRAWER.

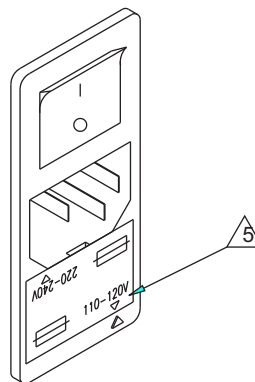

FRONT VIEW OF POWER MODULE WITH FUSE DRAWER RE-INSTALLED

5. RE-INSTALL FUSE DRAWER AS REQUIRED FOR THE SUPPLIED POWER PER SECTION 1.3.

4.10 DECONTAMINATION PROCEDURE

At a **minimum**, the following procedure should be performed before servicing the instrument or returning the instrument for any repair work:

1. Wear disposable rubber gloves, safety glasses and a lab coat while performing the following steps.
2. Use a cleaning pad wetted with a solution of one part chlorine bleach in nine parts water (10% bleach solution) to clean all outside surfaces of the Multiwash III. Use care to avoid getting bleach solution inside the chassis.
3. Dry the surfaces of the Multiwash III with paper towels or other disposable wipes.
4. Use cotton swabs to clean and dry areas that are hard to reach.
5. The Manifold should be disinfected by pumping bleach solution through it and then cleaning the outside surfaces with bleach solution. The Manifold may be immersed in 10% bleach solution for up to 10 minutes.
6. Properly dispose of used cleaning materials to insure no one becomes exposed to contaminants.
7. Keep in mind that this procedure does not guarantee total decontamination of the Multiwash III.
8. Wear disposable gloves at all times while servicing.

CAUTION: RESERVOIR BOTTLES CANNOT BE CLEANED IN A DISHWASHER.

Before returning any items, call TriContinent (see Appendix 2) to obtain a Return Material Authorization (RMA) number. If the instrument has been exposed to hazardous substances, the instrument **MUST** be cleaned and decontaminated. The correct disposal procedure documented in the material safety data sheets (MSDS) for each of the hazardous constituents must be followed. Contaminated items will not be accepted and will be returned to the user for proper cleaning.

Instruments and/or accessories returned must be accompanied by a letter certifying either: that the returned items have not been contaminated by body fluids, toxic, carcinogenic or radioactive materials, or other hazardous materials.

OR

that the returned items have been decontaminated and can be handled without exposing personnel to health hazards.

Repack the instrument in the original package prior to shipping, providing details about the use of hazardous substances along with a copy of the applicable MSDS.

5 TROUBLESHOOTING

5.1 RE-INITIALIZING THE STORED PROGRAMS

To re-initialize the Multiwash III's program settings, hold the Down Arrow key on the keypad as you turn the power switch on. This will return all user defined programs back to the factory settings!

5.2 TROUBLESHOOTING TABLE

The following checklist may help resolve problems in the operation of this equipment. Any problems that cannot be resolved by following the procedures below should be referred to qualified service personnel.

SYMPTOM	PROBABLE CAUSE	REMEDY
1. Instrument is "dead". Display is blank, the beeper does not sound when keys are pressed and motors do not operate.	AC power not getting to the instrument. Check Power Supply cable. Blown fuse.	Connect to Power Supply Cable.
	Instrument setup for the wrong voltage.	Replace fuse with proper type. See Section 4.9. Change voltage selector to the correct position. See Section 1.3.
2. Instrument doesn't respond to key presses.	Invalid data in instrument's stored programs. Caused by voltage spikes or fluctuations.	Hold "Down Arrow" key while turning on power to restore operation. A line conditioner or surge protector needs to be used. See Section 1.2.
3. Manifold hits plate when aspirating rows.	The manifold is not calibrated to the proper position within the wells.	Calibrate horizontal manifold position. See Section 1.5.2.
4. Instrument aspirates wells only partially, or not at all.	The manifold aspirate needles are partially or completely clogged.	Clean needles with supplied tool. See Section 4.6.
	Tubing is kinked or obstructed or is not connected properly.	Check connections, replace worn out tubing.
	The waste reservoir cap is loose, or fittings on cap are loose.	Tighten Waste reservoir cap, on bottle and all fittings.
	Manifold aspiration needles are not optimized for final aspiration.	Adjust Horizontal manifold position Section 1.5.2. Adjust vertical manifold position Section 1.5.3. Verify correct plate selection Section 3.3.8.

5.2 TROUBLESHOOTING TABLE (CONTINUED)

SYMPTOM	PROBABLE CAUSE	REMEDY
5. Unit dispenses only partially, or not at all.	The manifold dispense needles are clogged, or have cracked glass.	Clean or replace needles. See Sections 4.6-4.7.
	The Wash reservoir inlet filter is clogged.	Backflush or replace filter. See Section 4.3.
	Tubing is kinked or obstructed or is not connected properly.	Check connections, replace worn out tubing. See Section 1.6.
6. Instrument overfills wells.	Clogged dispense or aspirate needles.	Clean aspirate and dispense needles. See Sections 4.6-4.7.
	The aspiration pump or Waste reservoir tubing are kinked, obstructed, or connected improperly.	Check connections, replace worn out tubing, See Section 1.6.
	The cap on the Waste reservoir is loose.	Tighten cap.
	Manifold needles are not parallel to the well strips.	Adjust the manifold so that it is level. See Section 1.5.1.
7. Waste reservoir sensor does not register "FUL" when submerged in liquid.	Accumulated residue preventing float switch from functioning.	Clean float switch (on probe attached to inside of waste bottle cap).
8. Manifold hitting plate after washing several rows properly.	Tubing length incorrect causing pulling/pushing of manifold out of alignment.	Reposition tubing to the proper lengths. See Section 4.8.
9. Manifold aspirate (metal) needles are bent.	Dropping of the manifold or repackaging with proper padding.	Carefully push the needle/needles back into straight alignment.
10. Waste bottle collapses.	The aspirate needles in the manifold are clogged.	Clean the manifold needles with supplied tool.

5.2 TROUBLESHOOTING TABLE (CONTINUED)

SYMPTOM	PROBABLE CAUSE	REMEDY
11. Grinding noise from the back of the instrument and no fluid movement.	Syringe plunger is stuck due to dried wash buffer freezing the plunger to the syringe.	Turn the power Off and On and verify if syringe is working.
		Turn the power Off. Take a large standard screw driver and turn the Stepper Motor Nut, counter clockwise 5 turns. Turn the Power On.
	The Syringe assembly needs to be replaced with replacement, Catalog # 945. Follow the directions supplied with the replacement kit.	The Syringe assembly needs to be replaced with replacement, Catalog # 945. Follow the directions supplied with the replacement kit.
	Syringe plunger is out of follower.	See symptom #13.
12. Syringe plunger pops out of traveler nut.	Kink or blockage in tubing from Wash and Rinse reservoir, to the syringe valve.	Clear inlet tubing of all obstructions. Reset syringe plunger.
	Wash and rinse reservoir inlet filter clogged.	Backflush or replace filters.
		The syringe motor assembly needs to be replaced. Contact your distributor for assistance. See Appendix 2.
	13. "E02" displayed.	Syringe plunger has become disconnected, or jammed. See symptoms #11 and 12 for possible causes.
14. Any ERROR code other than "E02".	Damage to the instrument by electrical outage, brown out, low voltage, or high voltage spikes.	Turn off instrument to reset it and contact your distributor for assistance. See Appendix 2.

5.3 ERROR CODES

Internal faults during the operation of the Multiwash III result in error codes being reported on the front panel display of the instrument. The table below lists the error codes and their meanings. The Multiwash III should be turned off after the error code is recorded. Turning off the Multiwash III resets the instrument and clears out the error code from the display.

OPERATIONAL ERROR CODES		Note: The instrument will show a 0, 1, or 2 in place of the “?” shown on the instrument display. ?=0 is the pump, Max number of steps is 2272 ?=1 is the horizontal axis, Max number of steps is 2400 ?=2 is the vertical axis, Max number of steps is 350
E?1	No data	An instruction was issued to move a stepper motor without data in the proper register to specify how far to move. Check program and calibration parameters and the Logic PCBA.
E?2	Incorrect signal from opto	An instruction checking the status of the opto indicated that the status is not correct for the following conditions: Condition 1: Tried to move 5000 steps to the limit opto but the opto was never blocked. Condition 2: At the end of a move the opto should NOT be blocked, but it is.
E?3	No room from Limit	An instruction has been received for a stepper motor to move away from its Limit by more steps that are available. Check program and calibration parameters and Logic PCBA.
E?4	No room to Limit	A stepper motor reached its Limit opto before the requested move can be completed. Check program and calibration parameters and the Logic PCBA.
E?5	Limit error	A stepper motor reached its Limit opto before the requested move towards Limit was completed. Check the stepper motors, stepper motor drive circuits, Limit optos, and associated components on the Motor PCBA, 7360; Logic PCBA, 7752 and the Limit Optos PCBA's 8007.
E?6	Data range error	The data for instruction is outside the capabilities of the unit. Check program and calibration parameters and the Logic PCBA.
E?7	Already at max.	An instruction has been received for a stepper motor to move away from its Limit, but it is at its maximum position from Limit. Check the stepper motors, stepper motor drive circuits, Limit optos, and associated components on the Motor PCBA, 7360; Logic PCBA, 7752 and the limit Optos PCBA's 8007.
E?8	Already at Limit	An instruction was issued to move a stepper motor to Limit when it was already at Limit. Check the stepper motors, stepper motor drive circuits, Limit optos, and associated components on the Motor PCBA, 7360; Logic PCBA, 7752 and the Limit Optos PCBA's 8007.
E?9	Valve time out	No valve opto response has been received in the allotted time after a valve movement instruction was issued. Check the valve motor, motor drive circuitry, the valve position optos and associated circuits.

5.4 USER TROUBLE SHOOTING NOTES

6 SPECIFICATIONS

6.1 PERFORMANCE

Resolution	10 μ L
Accuracy @ 300 mL	< \pm 3% per TriContinent procedure QUA94081*
Precision (repeatability) @ 300mL	<3% CV per TriContinent procedure QUA94081*
Processing Time using Plate Wash Mode (full plate)	300 μ L x 3 cycles x 8-port manifold: 180 sec. 300 μ L x 3 cycles x 12-port manifold: 120 sec.

Dispense volume range per well	8-port manifold	50uL - 1990 μ L
	12-port manifold	50uL - 1650 μ L

Prime Cycle Volume (approximate)	8-port manifold	21mL
	12-port manifold	22.5mL
Rinse Cycle Volume (approximate)	8-port manifold	39.5mL
	12-port manifold	41mL
Standby Well Refill (approximate)	8-port manifold	3mL
	12-port manifold	4.5mL

Residual aspiration volume	<3 μ L per well
Liquid contact materials	Glass, Nylon, Stainless Steel, Polypropylene Tygon®, Teflon®, Delrin®, Polyethylene, Santoprene

**Available upon request*

6.2 MECHANICAL / ELECTRICAL

Dimensions (h x w x d):	9.5"h x 11.5"w x 16.0"d (242 x 292 x 406mm)
Weight (approximate):	12 lbs, instrument only
	21 lbs, domestic shipping wt.
	25 lbs, international shipping wt.

Line Voltage Req:	110/120VAC	220/240VAC
Line Current Req:	375mA	160mA
Line Voltage Tolerances (\pm 10%):	99-132VAC	198-264VAC
Frequency:	50/60 HZ	
Power consumption:	30 watts max.	
Replacement Fuse:	110/120VAC	375mA TT (Slow Blow) 1/4" x 1 1/4"
	220/240VAC	160mA TT (Slow Blow) 5 x 20 mm

Operating temperature:	10° to 40°C
Storage temperature:	1° to 40°C

Fluid reservoir capacity:	Wash, Rinse, Waste: 2L
---------------------------	------------------------

APPENDIX 1 ACCESSORIES AND REPLACEMENTS

To view or download Accessories and/or Replacement items for the MultiWash III, please visit our website www.tricontinent.com

APPENDIX 2

ORDERING INFORMATION/CUSTOMER SERVICE

Assistance with the operation or repair of the MultiWash III is available by contacting:

Phone - 530-273-8888 or 800-937-4738

E-mail - LiquidHandling.TCS@gardnerdenver.com

WARRANTY

WORKMANSHIP AND MATERIALS

The Multiwash III is warranted against defects in materials and workmanship for a period of two years from the date it is shipped from the manufacturer. If notified of such defects during the warranty period, manufacturer will, at its option, either repair or replace products which prove to be defective. Please refer to the TriContinent website www.tricontinent.com for detailed warranty and return information.

SERVICING

DO NOT ship the instrument back for repair until you are advised to do so.

DO NOT attempt to repair the instrument, removing the case will nullify the warranty. In the event that the product is inoperable please call or fax your distributor and they will provide full failure details. When making your call, please ensure that you have the serial number of the instrument.

In the event that you are requested to return the instrument or any parts thereof IT IS YOUR LEGAL REQUIREMENT to ensure that the instrument is fully DECONTAMINATED (see section 4.10) and that a certificate to verify decontamination is present in the returned box. Failure to do this may result in the refusal to repair the instrument. Your distributor will issue a Return Material Authorization (RMA) number. This number is to be marked on the outside of the shipping box.



EXCLUSIONS

The above warranty shall not apply to defects resulting from improper or inadequate maintenance by the customer, unauthorized modification or service, misuse, operation outside of the environmental specifications for the product, or instruments returned with inadequate packaging. It is the responsibility of the purchaser to determine the suitability of an application and material compatibility of the products. There is also no warranty expressed or implied for valves, syringe plungers or seals. For equipment damaged in shipping, contact the shipper.

APPENDIX 3 QUICK START GUIDE

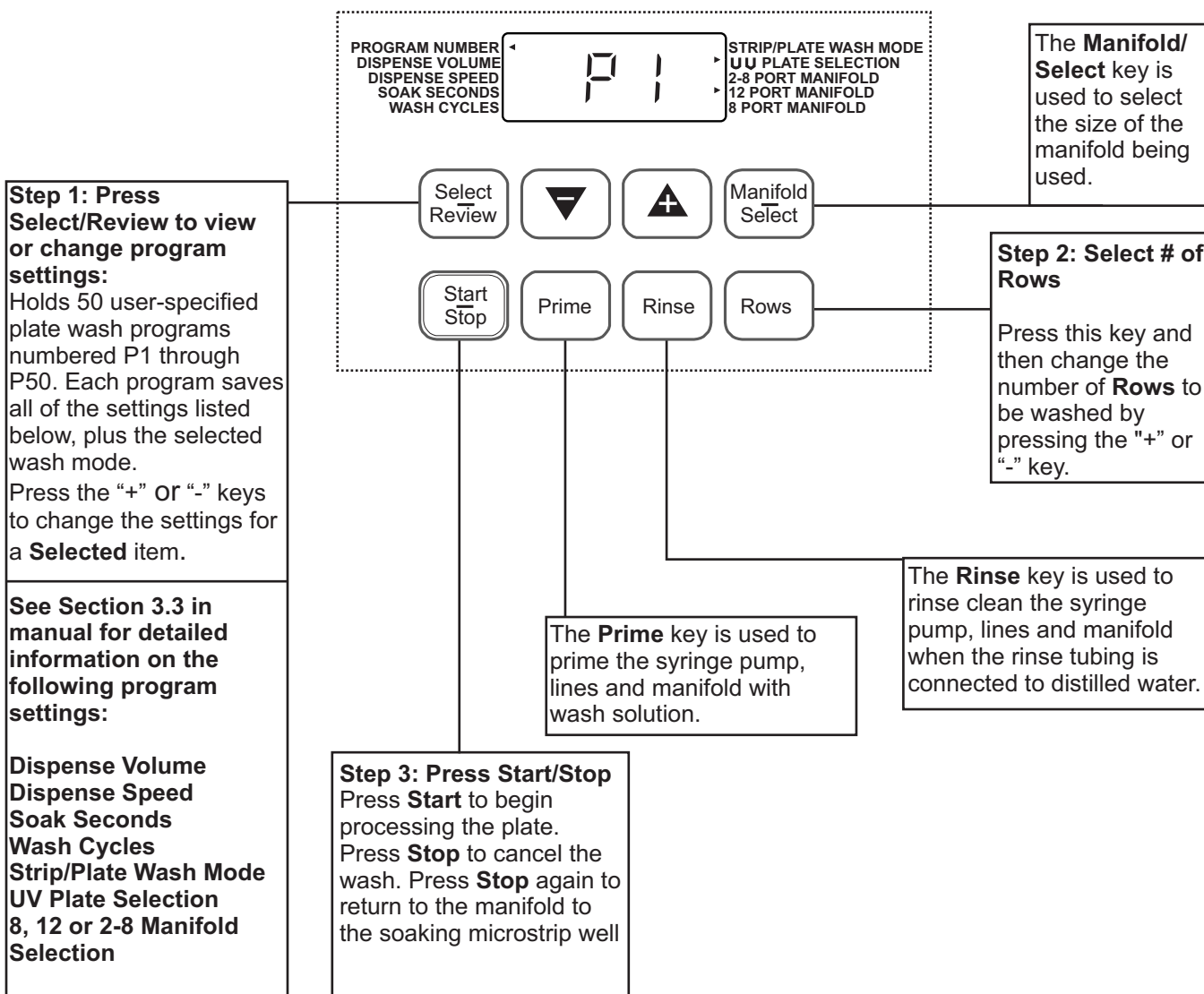
See instructions for fuse module installation, setting up the reservoirs, and installing the manifold tubing in Section 1.



When changing settings by a large amount, holding down the  or  keys will speed your entry.